

KUPOLE SYSTEM

POLESTAR 13



BRILLIANT SPACE ORGANIZER



POLESTAR

LEADING SPATIAL DESIGN

Polestar, a quick-assemble shop fitting solution, offers comprehensive and complete range of accessories for shop display design. Ideal for shop and window display, sales promotion, showroom, exhibition and retail.

Fabricated in chic, slick and succinct design for upmost eye-catching presentation, Polestar also features in greatest flexibility and mobility to where construction space or timeframe is limited. With wide selections of connecting accessories, your visual merchandising can be escalated and create a new dialogue with clients.

GALLERY	02
● KUPOLE	16
● SPORTS GEAR RACK	52
● SUPER JOINT	62
● PIPE CLAMP	68
● X-BONE	72

KUPO DISPLAY













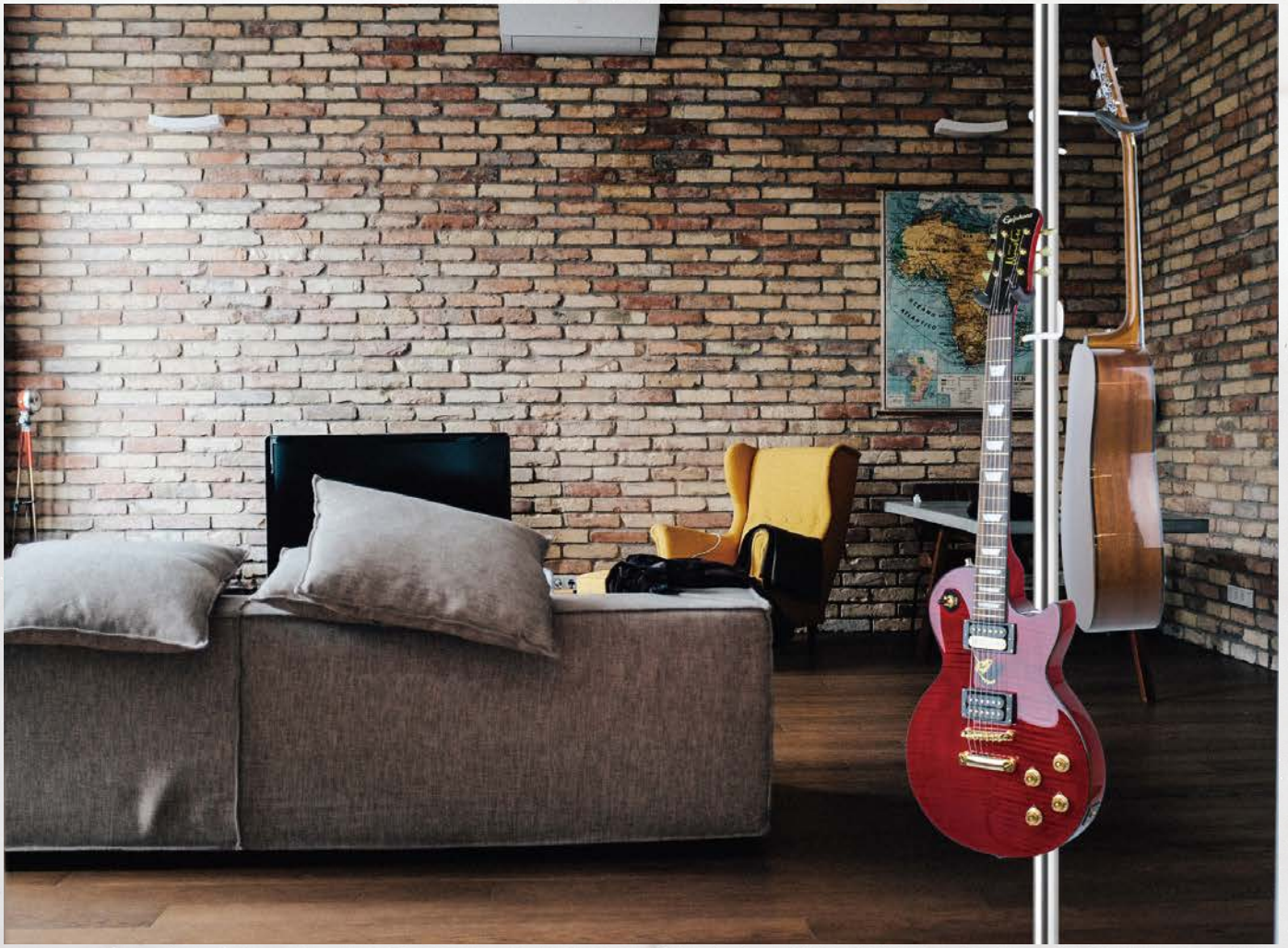









COMBINATION

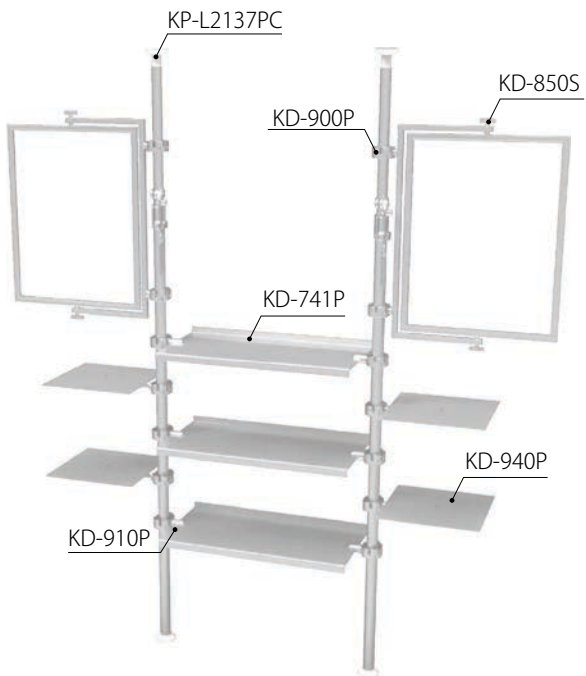

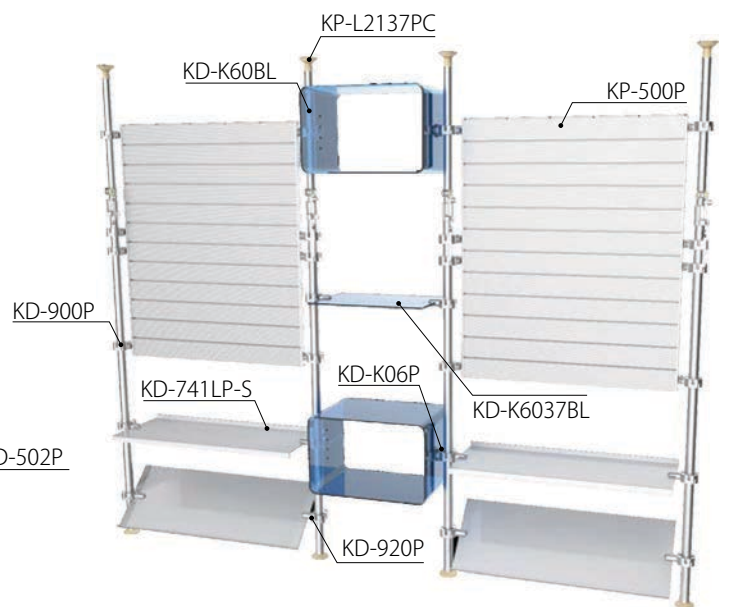

KUPOLE





KUPOLE:

Kupole is an extremely versatile support. It takes less effort and no complicated set-up and tool. The Kupole is fabricated of spring-loaded 2-section aluminum poles and available in 3 models, and the maximum height can reach up to 370cm. Unique spring locking expansion system secures the Kupole firmly in between ceiling and floor, occupying as smaller as 2" diameter space footprint to create a time-saving mounting solution.

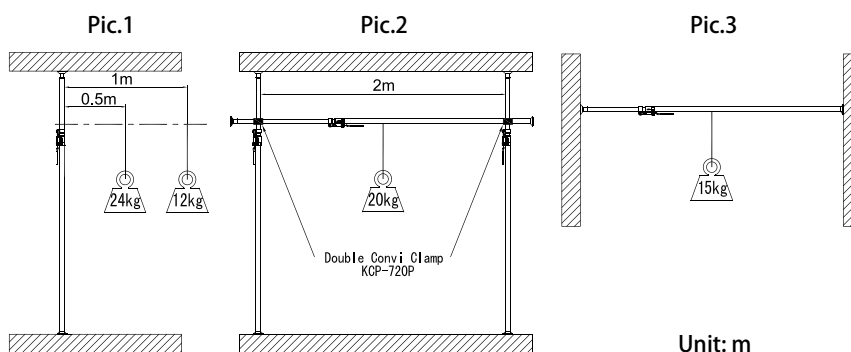
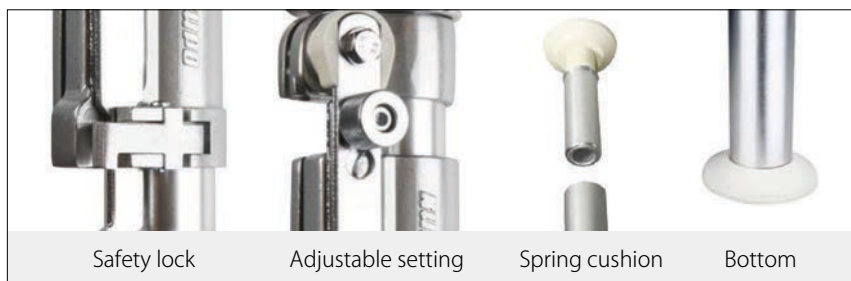

LOADING LIMITS:

- Picture 1 & 2 are valid for using with rigid floor and ceilings, with the rubber pad attached to the rubber cover.
- Picture 3 is valid for operating with rigid wall to wall, with the rubber pad attached to the rubber cover.

KUPOLE WITH CURVY HANDLE

- Upper tube DIA. 4cm
- Lower tube DIA. 4.5cm



YouTube
KUPO KUPOLE
(KP-L2137LB)

KP-L2137PC / Polish
KP-L2137BC / Black

- Height extends from 210cm to 370cm

KP-M1527PC / Polish
KP-M1527BC / Black

- Height extends from 150cm to 270cm

POLE

KUPOLE



KUPOLE DELUXE

- With deluxe aluminum casting handle.
- Upper tube DIA. 4cm
- Lower tube DIA. 4.5cm

KP-L2137PD / Polish

KP-L2137BD / Black

- Height extends from 210cm to 370cm

KP-M1527PD / Polish

KP-M1527BD / Black

- Height extends from 150cm to 270cm

KP-S1017PD / Polish

KP-S1017BD / Black

- Height extends from 100cm to 170cm



KP-SP02
White Top
Rubber Cover



KP-SP03
White Bottom
Rubber Cover



KP-SP04
Black Top
Rubber Cover



KP-SP05
Black Bottom
Rubber Cover



KP-SP01 White Rubber Pad

This pad keeps your ceiling and floor nice and clean from leaving a circular mark or a dirt rubber pad ink. Fit for both top and bottom rubber cover





GYRO-POLE

Constructed from lightweight aluminum with unique tension adjustable mechanism on the bottom, Gyro pole offers an effortless and effective solution to adjust the tightness by just twisting to lock and release without release the clamping collar.

KPG-L2137P / Polish

- Height extends from 210cm to 370cm
- Upper tube DIA. 4cm
- Lower tube DIA. 4.5cm



STEEL KUPOLE

Constructed from rugged steel with elegant powder coating surface treatment, this steel Kupole provides an ideal storage solution specially for household and garage.

KPS-L2137GC / Gray

- Height extends from 210cm to 370cm
- Upper tube DIA. 4cm
- Lower tube DIA. 4.5cm



POLE

KUPOLE

BANNER POLE

This banner pole is made of lightweight aluminum. It can be freestanding by securely mounted on the steel round base. The unique twist-to-lock mechanical locking design allows you to adjust the height of pole with ease and comfort. A great banner pole kit to meet your need of banner or poster display.

- Height extends from 160cm to 280cm
- Upper tube DIA. 4cm
- Lower tube DIA. 4.5cm
- Maximum load 10kg



KP-1628P / Polish

- Banner Pole with Base
- 1 Banner Pole
- 1 KD-R48P-4MM



KP-1628P-SETA / Polish

- Banner Pole Set
- 1 Banner Pole
- 1 KD-R48P-4MM
- 2 KD-900P
- 2 KD-816P



You Tube
KUPOLE FT.
BANNER POLE SET



KUPOLE LOWER TUBE

Aluminum tube with silver anodized or black powder coated finish which can be mounted on the disc base, wall or ceiling with specific accessories.

KP-L2137-45P / Polish
KP-L2137-45B / Black

- Tube DIA. 4.5cm
- Length: 178cm
- Aluminum tube

KP-2700-45P / Polish
KP-2700-45B / Black

- Tube DIA. 4.5cm
- Length: 270cm
- Aluminum tube

- Custom size available

STEEL TUBE

Steel tube with powder coated finish which can be mounted on the disc base, wall or ceiling with specific accessories. 2,700mm in length is perfect for shop.

KPS-2700-45P / Polish
KPS-2700-45B / Black

- Tube DIA. 4.5cm
- Length: 270cm
- Steel tube

KUPOLE EXTENSION

Aluminum tube for extension when encountering higher ceiling or farther wall. Just remove the top pad, add the extension to the top section, replace the top pad and you now can reach new heights with your Kupoles.

- Tube DIA. 4cm
- Inserts into top of Kupole

KP-X15P / Polish
KP-X15B / Black

- Height 150cm

KP-X20P / Polish
KP-X20B / Black

- Height 200cm

CLAMP

KUPOLE

CONVI CLAMP

The all-metal Convi Clamp is made from a lightweight alloy that can be securely mounted on any tubing size from 5 to 50 mm in diameter. It features a hexagonal receiver that accepts dozens of interchangeable Convi accessories. A spring locking safety system is equipped to ensure that the Convi accessory will not separate from the clamp if the locking screw loosens unexpectedly.



KCP-700P / Silver

KCP-700B / Black

- The jaw grip from 1.3cm to 5.5cm
- Attach accessories to Kupole, Span or Tube
- Maximum load 20 kg

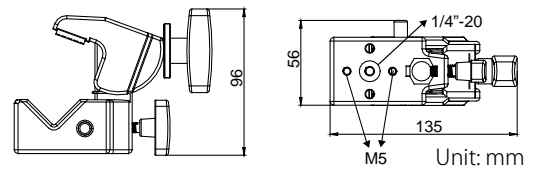

YouTube

KUPO CONVI CLAMP SYSTEM KCP-700



CUSTOM COLORS & LASER ENGRAVING LOGO ARE AVAILABLE UPON REQUEST! (MOQ 200 PCS)



DONUT

This all metal cast aluminum clamp features a unique spring locking mechanism that allows to instantly latch and release the collar on any tubing size from 4cm to 4.5cm in diameter. Just a quick turn of the tension knob to secure it in place and 3 recessed mounting location distributed in 90 degree make it accept a series of interchangeable accessories.



KD-900P / Silver

KD-900B / Black

- Clamp tubes from DIA.4cm to 4.5cm
- Attaches up to 3 accessories to tube
- Maximum load 25 kg



Gorgeous & Unbeatable

- Lightweight: pocket-size gadget, only 350g
- Sturdy: fabricated of die-cast high tensile aluminum alloy
- Flexible: quick and spring locking design makes it suitable for pole gauge of DIA. 4 - 4.5cm
- Versatile: feasible to various mounting kits

THE 3-WAY MOUNT

Recessed fixing slots in every 90 degree, accommodates a variety of interchangeable mounting accessories.



RUBBER PAD

Keeps pole away from scrape, as well as offers firm skid-proof locking.



SPRING LOCKING DEVICE

Just a quick turn of the tension knob to secure it in place, and you are ready to mount any accessory to pole or Kupole in a snap.



YouTube

KUPO DOUNT KD-900P & KD-900B

ONE WAY CLAMP

Constructed from rugged steel with elegant powder coating surface treatment, this one way clamp equipped with magnetic brake pad is built for directly attaching to the steel Kupole with ease and comfort. The recessed mounting location makes it accept a series of interchangeable accessories.



YouTube
SPORT GEAR RACK
400 SERIES

KD-400

- Clamp tubes from DIA. 4cm to 4.5cm
- Magnetic brake with rubber pad grasps onto the steel Kupole firmly without slip-off.

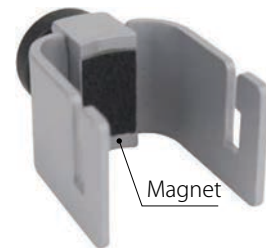

Protection rubber pad are added to keep Kupole away from scratches.

VIVI-RING

Rotating cast aluminum ring which can be surely mounted on the tube size from 4cm to 4.5cm in diameter allows hanging your merchandise by inserting the rods into the threaded holes.



KD-600P Vivi-Ring with M10 Female Thread

- Clamp tubes from DIA. 4cm to 4.5cm
- Rotating clamp with 4 M10 holes



KD-601P Vivi-Ring with M6 Female Thread

- Clamp tubes from DIA. 4cm to 4.5cm
- Rotating clamp with 8 M6 holes



YouTube
KUPOLE FT.
ROTATING HANGER (VIVI-RING)



1. Mount the inner clamp on the pole and tighten the screw with # 3 Allen key to keep it in place on the pole



2. Mount the rotating ring on the inner clamp and tighten the screw with # 2.5 Allen key



3. Twist to lock hanger rod on the Vivi-Ring

VIVI RING



KD-602P Vivi-Ring with Hanger Rod

- Clamp tubes from DIA. 4cm to 4.5cm
- Rotating clamp with 4 screwed rods
- Rod size: DIA. 1.4cm
- Length: 25.6cm



KD-603P Vivi-Ring with Hanger Rod

- Clamp tubes from DIA. 4cm to 4.5cm
- Rotating clamp with 8 screwed rods
- Rod size: DIA. 0.6cm
- Length: 20.6cm



KD-604P Bicycle Helmet Holder

- Vivi-ring with 4 rods and 4 clear acrylic
- Rod size: DIA. 1.4cm, 10cm L
- Acrylic size: 25cm L x 8cm W x 12cm H



You **Tube**

KUPOLE FT.
ROTATING HANGER
(VIVI-RING)



ROUND TABLE

Smart gadget for mounting a plank from 1 to 2.5cm thickness with 3 M6 screws as a table by means of locking on the tube size 4 to 4.5 cm in diameter.



KD-655P
Holding Ring For Table



- Clamp tubes from DIA. 4cm to 4.5cm
- With 3 M6 screws
- Accept material: 1cm up to 2.5cm thick

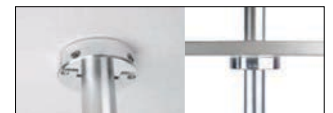

White round table in wood veneer is perfect for having a stylish table mounted on the pole system to display your merchandise, a workstation in the office, or a storage table blended effortlessly in your home. Superior aluminum clamping adapter equipped underneath the table can be easily mounted the table on the pole with #5 Allen key.



KD-650W
Kupole Round Table

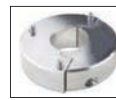

- Dia. 60cm
- Weight: 5kg
- Maximum load: 20kg
- Material: White board
- (Polished Hardware KD-655P included)



YouTube
KUPOLE FT.
ROUND TABLE

SLAT PANEL

Aluminum slat panels provide a convenient yet visually appealing method for displaying your products. It requires four donut clamps (KD-900, sold separately) to be mounted between two poles. It fits clamp system display accessories including shelves, poster holders, clips, rails, shoe panels and most of standard slat wall accessories greatly expanding the functionality of the system.

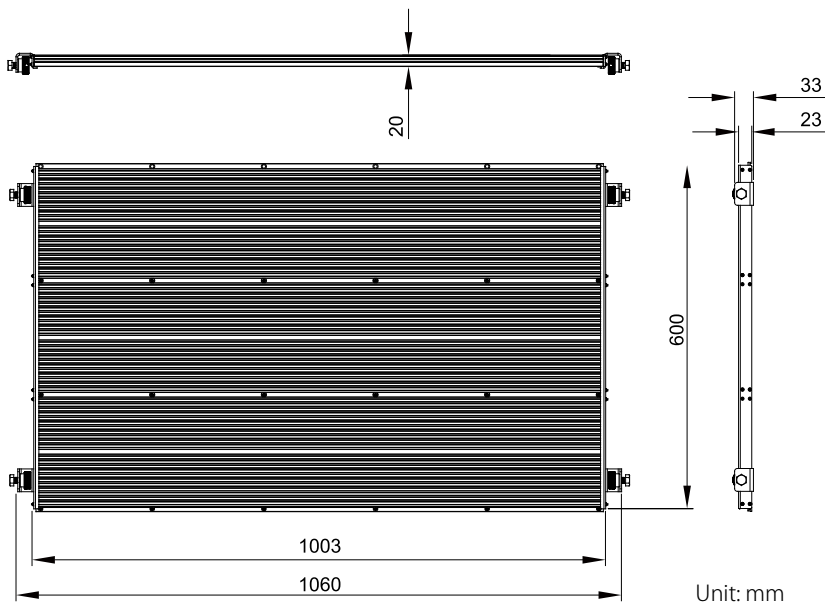

YouTube
**KUPOLE FT.
ALUMINUM SLAT PANEL**

- Maximum load 30 kg
- Mounting on 4 KD-900, 4 KD-C05
- Material: Aluminum Alloy 6061-T6
- Finish: Anodizing with Sandblasting

KD-500P / Silver Aluminum Slat Panel

- 106cm W x 60cm L x 2cm T
- Weight: 6kg

KD-500DP / Silver Aluminum Double Sided Slat Panel

- 106cm W x 60cm L x 5cm T
- Weight: 12kg

1. Align the screw with the recessed mounting location.



2. Slide the screw into the recessed mounting location.



3. Turn to lock the knob and use the tool through the hole if necessary.



SLAT PANEL

Poster holder set (4 pcs per set) is designed for holding customized poster acrylic panel with M6 knob and can be precisely inserted into the groove of slat panel.



KD-501P / Silver Poster Holder (w/o panel, poster)

- Set of 4
- 4.5cm L x 3cm W x 2cm T with M6 Knob
- Mounting on KD-500P or KD-500DP

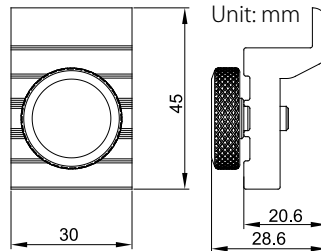

Constructed from lightweight aluminum structure with angle-adjustable locking system and anti-slip pad on the surface which allows to keep shoe displayed in place at 3 different degree including 15, 30 and 180.



KD-502P / Silver Shoe Panel

- 25cm W x 13cm D with M6 Knob
- Adjustable Angle: 15, 30 or 180 degree
- Mounting on KD-500P or KD-500DP

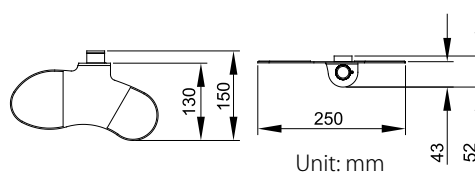

Constructed from lightweight aluminum structure with M6 knobs as stoppers to keep the display shelf in place. It has extreme flexibility and mobility on the slat panel to display your merchandises.



KD-503P / Silver Display Shelf

- 45.6cm W x 30cm D with M6 Knob
- Mounting on KD-500P or KD-500DP
- Maximum load 4 kg

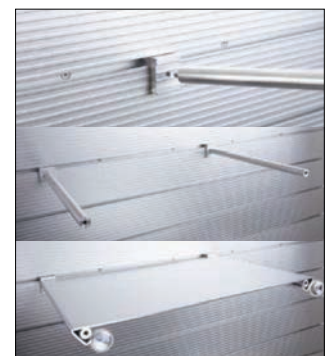
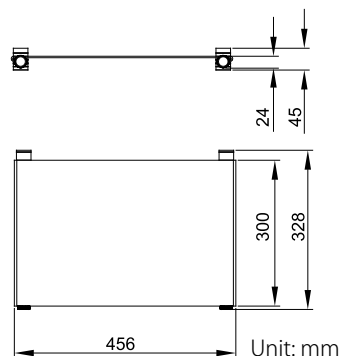

PANEL HOLDER

KUPOLE



KUPO PANEL HOLDER
KD-910 & KD-920



KD-910P / Polish
KD-910B / Black
Panel Holder



- Attach panels or shelves to KD-900, KD-C05
- Accepts material up to 0.8cm thick



Square neck for vertical and horizontal fitting.



KD-920P / Polish
KD-920B / Black
Rotating Panel Holder



- Attach panels or shelves to KD-900, KD-C05
- Accepts material up to 0.8cm thick



Round neck allows 360 degrees angle adjustment.

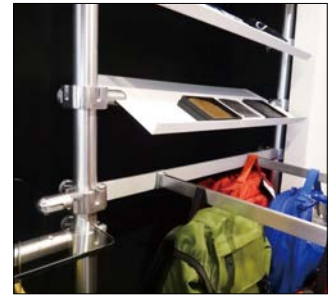

KD-910P-G / Polish
Panel Holder with Double Security



- Attach panels or shelves to KD-900, KD-C05
- Accepts material up to 0.8cm thick



Square neck for vertical and horizontal fitting.



Two set screws to hold the panel for the double security.



KD-PR910P / Polish
Rotating Panel Holder



- Attach panels or shelves to KD-900, KD-C05
- Accepts material up to 0.8cm thick



Round neck allows 360 degrees angle adjustment.



Fix the angle through the black set screw.



PANEL HOLDER



KD-710P / Polish
KD-710B / Black
Panel Holder



- Attach panels or shelves to KCP-700
- Accepts material up to 0.8cm thick



Round neck allows 360 degrees angle adjustment.



KD-720P / Polish
KD-720B / Black
Panel Holder With Set Screw



- Attach panels or shelves to KCP-700
- Accepts material up to 0.8cm thick



KD-710P-C / Polish
Panel Holder

- Attach panels or shelves to KCP-700
- Accepts material up to 1.0cm thick



Hex neck allows six angle adjustment.

KD-712P / Polish
Panel Holder

- Attach panels or shelves to KCP-700
- Accepts material up to 1.2cm thick



KD-730P / Polish
KD-730B / Black
Convi Clamp
Additional Socket



- Mounting on KCP-700 as Double Convi Clamp



PANEL HOLDER

KUPOLE



KD-915P / Polish
KD-915B / Black
Tidy Panel Holder

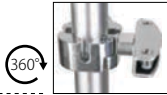

- Attach panels or shelves to KD-900, KD-C05
- Accepts material up to 1.2cm thick



KD-915P-2CM / Polish
Tidy Panel Holder (2CM)



- Attach panels or shelves to KD-900, KD-C05
- Accepts material up to 2.0cm thick



KD-990P / Polish
KD-990B / Black
L Bracket Shelf Holder



- Set of 2
- 17cm W x 4cm D x 4cm H
- Mounting on KD-900, KD-C05
- Aluminum material



KD-790P / Polish
KD-790B / Black
L Bracket Shelf Holder

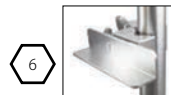

- Set of 2
- 17cm W x 4cm D x 4cm H
- Mounting on 2 KCP-700
- Aluminum material



YouTube
KUPO SHELF HOLDER
KD-915 & KD-915P-2CM
& KD-990



KD-991P / Polish
KD-991B / Black
L Bracket Shelf Holder
With Knob



- Set of 2
- 17cm W x 4cm D x 4cm H
- Mounting on KD-900, KD-C05
- Aluminum material
- Knob design for easy installation



HOOK



KD-812P / Polish
KD-812B / Black
U Hook

- 4.4cm depth
- Mounting on KCP-700, KD-900, KD-C05



KD-813P / Polish
KD-813B / Black
Compact U Hook

- 1.6cm depth
- Mounting on KCP-700, KD-900, KD-C05



KD-795P / Polish
KD-795B / Black
Compact U Hook

- Set of 2
- 1.6cm depth
- Requires 2 KCP-700
- Aluminum material



KS-012 / Polish
U Hook

- Set of 2
- 4.4cm depth
- Requires 2 KCP-700
- Steel material



The holder is made of lightweight & durable aluminum with dia. 7.4cm space which allows to hold vase, hair dryer or a coffee cup.



KD-815P / Polish
Vase Holder

- DIA. 7.4cm
- Mounting on KCP-700, KD-900, KD-C05



POSTER HOLDER

KUPOLE

The handy steel spring clamp provides an excellent mounting solution for your posters that can be surely clipped by its spring tension clamp and easily connect to the Donut (KD-900) or Convi Clamp (KCP-700).



YouTube
KUPO ALI CLAMP
KCP-350 & KCP-360



KCP-350P / Polish
KCP-350B / Black
Mini Ali Clamp

- Mounting on KD-900 with KS-020S
- For poster and banner
- Steel material

KCP-360P / Polish
KCP-360B / Black
Ali Clamp

- Mounting on KD-900 with KS-020S
- For poster and banner
- Steel material

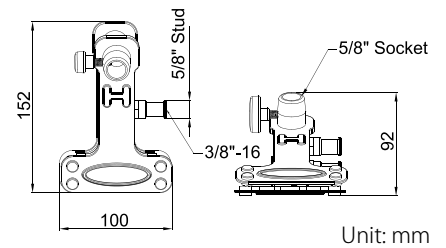
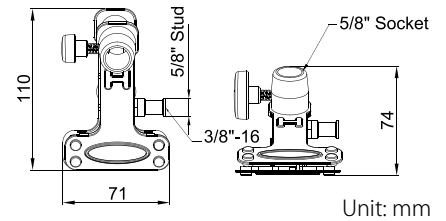

KS-020S / Polish
Aluminum Round Adapter

- For KCP-350 or KCP-360 to KD-900
- Requires KD-900, KD-C05

Aluminum made double end stud is designed for connecting Ali clamp in one end, allowing 360 degrees angle adjustment while mounted on Dount (KD-900) with the square end.



KD-0730P / Polish
KD-0730B / Black
Mini Ali Clamp with Stud

- KCP-350 + KS-017 Mounting on KCP-700
- For poster and banner
- Steel material

KD-0731P / Polish
KD-0731B / Black
Ali Clamp with Stud

- KCP-360 + KS-017 Mounting on KCP-700
- For poster and banner
- Steel material

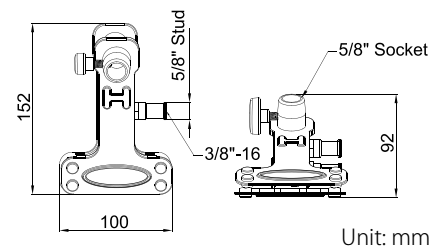
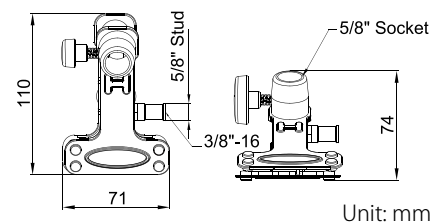

KS-017
Copper Adapter

- For KCP-350 or KCP-360 to KCP-700
- Requires KCP-700

Brass made double end round stud is designed for connecting with Ali clamp in one end allowing 360 degrees angle adjustment while mounted on Convi clamp (KCP-700) with the other end.

POSTER HOLDER



KD-0732P / Polish
KD-0732B / Black
Mini Ali Clamp with Hex Stud

- KCP-350+KS-020 Mounting on KCP-700
- For poster and banner
- Steel material

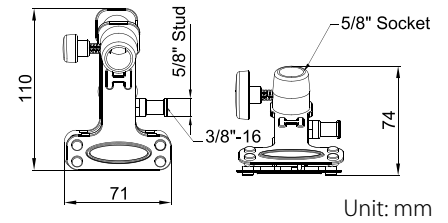

KD-0733P / Polish
KD-0733B / Black
Ali Clamp with Hex Stud

- KCP-360+KS-020 Mounting on KCP-700
- For poster and banner
- Steel material

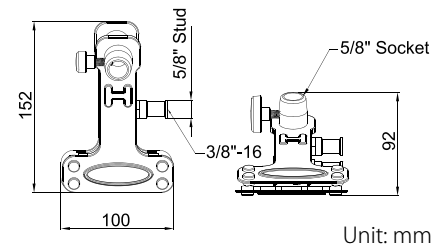

KS-020
Aluminum Hex Adapter

- For KCP-350 or KCP-360 to KCP-700
- Requires KCP-700

Aluminum made double end stud is designed for connecting with Ali clamp in round end that keeps the clamp from rotating while mounting on Convi clamp (KCP-700) with the hex end.



YouTube
KUPO ALI CLAMP
KCP-350 & KCP-360



KD-800P / Polish
Telescopic Signholder

- Adjustable from 51cm to 152.5cm
- Includes 4 KCP-350P
- Mounting on KCP-700, KD-CF16P or KD-CM16P



POSTER HOLDER

KUPOLE

The handy aluminum spring clamp provides an excellent mounting solution of your posters that can be surely clipped by its spring tension clamp and easily connected to the Donut (KD-900) with the 5/8" adapter terminated at the bottom of the clamp.



KD-816P / Silver
KD-816B / Black
Square Clip

- 5.3cm W x 9cm H
- Mounting on KCP-700, KD-900, KD-C05



YouTube
KUPOLE FT. SQUARE CLIP
KD-816



This screen holder features an unique V-shaped design which display your poster in front of Kupole, revealing complete poster for collage and montage.



KD-817P / Polish
Graphic Panel Holder

- 11cm L x 9.4cm W with 2 M8 x 12mm Knobs
- Adjustable Angel: 90, 135 or 180°
- Accept material: 0.6cm thick
- Mounting on KD-900



YouTube
KUPOLE FT.
GRAPHIC PANEL HOLDER



The curved frame set is designed for easy display dual 59cm(W)x 72cm(H) curve panel that allows to attract more viewers from both sides.



KD-0930P / Polish
Curved Frame

- 53cm W x 72cm H
- Accept two 59cm W x 72cm H curve panels
- Mounting to Kupole, includes 2 KD-900



POSTER HOLDER



KD-983TP / Polish Banner Rod with Screw

- 61cm L
- DIA.2.5cm
- Mounting on KD-900, KD-C05
- Aluminum material



You Tube
KUPOLE FT. BANNER ROD



KD-760SP / Polish Banner Rod with Stud

- 61cm L, DIA. 2.5cm
- Mounting on KCP-700
- Aluminum material



You Tube
KUPOLE FT. BANNER ROD



KD-760TP / Polish Banner Rod with Thread

- 61cm L, DIA. 2.5cm
- Mounting on KCP-700
- Aluminum material



You Tube
KUPOLE FT. BANNER ROD



KD-735P / Polish Mini Flex Arm with Alligator Clip

- It is the perfect accessory to hold small items such as a menu or logo plate.
- 23cm L
- Mounting on KCP-700
- Available in Chrome Plated



You Tube
KUPO MINI FLEX ARM W/
ALLIGATOR CLIP (KD-735P)



SIGN FRAME

KUPOLE



KD-850S / Polish Sign Frame Sidemount

- 55cm W x 70cm H graphic size
- Accepts material up to 0.6cm thick
- Requires 2 KCP-700 or 2 KD-900
- Steel material



The steel made sign frame features an angle adjustable locking knobs which allows to display the sign at any angle.



**KUPOLE FT.
POSTER/MIRROR FRAME**



KD-851S / Silver KD-851B / Black Mirror Frame

- 59.5cm W x 110cm H mirror size or graphic size
- Accepts material up to 0.6cm thick
- Requires 4 KCP-700 or 4 KD-900
- Aluminum material



The aluminum mirror frame features a full length design fitting perfectly on Kupole system with Convi clamp (KCP-700) or Donut (KD-900) allows to create unique aesthetic in your own space and surly an ideal for hair & beauty salon.



SIGN FRAME



You Tube
KUPOLE FT.
POSTER/MIRROR FRAME



- Accepts material up to 0.6cm thick
- Mounting on KCP-700, KD-CF16P or KD-F95P



KD-751P / Polish
Sign Frame Tripod / Ceiling

- 55cm W x 70cm H graphic size
- Steel material



KD-752P / Silver
Sign Frame Tripod / Ceiling

- 27cm W x 35cm H graphic size
- Aluminum material



You Tube
KUPOLE FT.
ROUND FRAME

- Accepts material up to 0.6cm thick
- Includes square base 25cm
- Aluminum frame with steel base



KD-753P / Silver
Sign Frame with Base

- 39cm W x 55cm H graphic size



KD-854S / Silver
Round Frame with Base

- DIA. 50cm

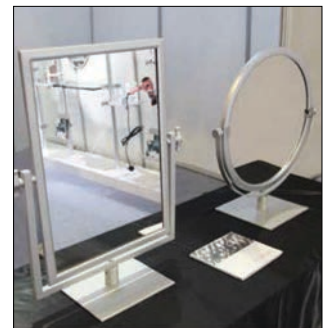
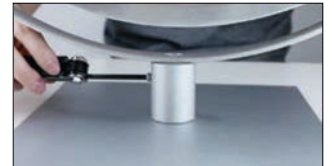

Aluminum made round frame comes with adapter which is a great display solution for your poster or mirror on pole through Donut (KD-900) , Mini Donut (KD-C05), Convi Clamp (KCP-700). It accepts material up to 0.6cm thick.



KD-855S / Silver
Round Frame

- DIA. 50cm

KD-856S / Silver
Round Frame

- DIA. 60cm



You Tube
KUPOLE FT.
ROUND FRAME



SHELF



KD-940P / Polish Display Shelf

- 38cm square
- 37cm adjustable extension
- Mounting on KD-900, KD-C05
- Maximum load 4.5 kg



KD-740P / Polish Display Shelf

- 38 cm square
- 37 cm adjustable extension
- Mounting on KCP-700
- Maximum load 4.5 kg

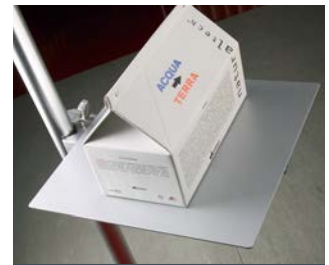

Steel holding arm is available for connecting with customized display metal or acrylic shelf.

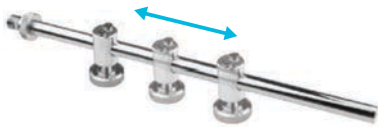

KD-940P-A / Polish Holding Arm

- 37cm adjustable extension
- Mounting on KD-900, KD-C05



KD-740P-A / Polish Holding Arm

- 37cm adjustable extension
- Mounting on KCP-700

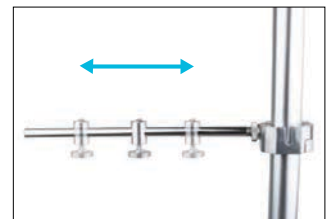

KD-947P / Polish Round Shelf

- DIA. 33cm
- 29cm adjustable extension
- Mounting on KD-900, KD-C05
- Maximum load 4.5 kg



KD-747P / Polish Round Shelf

- DIA. 33cm
- 29cm adjustable extension
- Mounting on KCP-700
- Maximum load 4.5 kg



YouTube
KUPOLE FT.
ALUMINUM
DISPLAY SHELF

Steel holding arm is available for connecting with customized display metal or acrylic shelf.

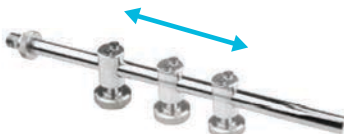

KD-970P-A / Polish Holding Arm

- 29cm adjustable extension
- Mounting on KD-900, KD-C05



KD-770P-A / Polish Holding Arm

- 29cm adjustable extension
- Mounting on KCP-700



DISPLAY BOX

Transparent acrylic show case prevents your merchandise from dust and damage with ease and comfort. Pre-drilled holes of the show case are available for tightening the knob to securely mounting the showcase on shelf.



KD-970P / Polish

- 30.5cm square acrylic
- 30.7cm shelf with bent edges
- 29cm adjustable extension
- Mounting on KD-900, KD-C05
- Maximum load 4.5 kg



KD-770P / Polish

- 30.5cm square acrylic
- 30.7cm shelf with bent edges
- 29cm adjustable extension
- Mounting on KCP-700
- Maximum load 4.5 kg



SHELF WITH BENT EDGES



KD-971P / Polish

- 30.7cm square
- 29cm adjustable extension
- Mounting on KD-900, KD-C05
- Maximum load 4.5 kg



KD-771P / Polish

- 30.7cm square
- 29cm adjustable extension
- Mounting on KCP-700
- Maximum load 4.5 kg



YouTube

**KUPOLE FT.
ALUMINUM
DISPLAY SHELF**



SHELF

BOTTLE RACK

Due to the aesthetically merchandise looks and utter functionality, this bottle rack provides you with a stylish and innovative way to display your wine in shop or store at home. Constructed from lightweight and durable aluminum alloy with silver anodized surface treatment, the bottle rack can hold up to 8 wine bottles or water bottles at a time. Simply mount it on the poles with Dounts (KD-900) and ready to go.



KD-9121P / Silver

- 106cm W x 28.5cm D
- Mounting on 2 KD-900, 2 KD-C05P



You Tube
KUPOLE FT.
SHELF & BOTTLE RACK



KD-741P / Polish Shelf with Bent Edges

- 76cm W x 38cm D
- Maximum load 30 kg

KD-741LP-S / Polish Shelf with Bent Edges

- 101cm W x 38cm D
- Maximum load 25 kg

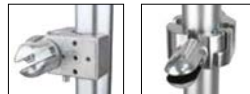

You Tube
KUPOLE FT.
SHELF & BOTTLE RACK

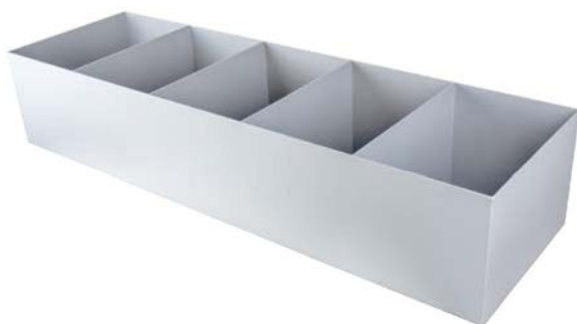

KD-772P / Polish Box Shelves

- 106 cm W X 30cm D X 20 cm H
- Maximum load 30 kg



You Tube
KUPOLE FT.
SHELF & BOTTLE RACK



YouTube
KUPOLE
BOOK SHELF



KD-942P / Polish Book Shelf

- 25cm W x 20cm D x 25cm H
- Mounting on KD-900, KD-C05
- Maximum load 9 kg



KD-943P / Polish Catalogue Shelf

- 25cm W x 8.6cm D x 25cm H
- Mounting on KD-900, KD-C05
- Maximum load 9 kg



KD-742P / Polish Book Shelf

- 25cm W x 20cm D x 25cm H
- Mounting on KCP-700
- Maximum load 9 kg



KD-743P / Polish Catalogue Shelf

- 25cm W x 8.6cm D x 25cm H
- Mounting on KCP-700
- Maximum load 9 kg



HANGER BAR

KUPOLE

RECTANGULAR CROSSBAR

This crossbar allows to fits between two Kuploe with Donut (KD-900).



YouTube

KUPOLE FT. HANGER BAR
(RECTANGULAR & SQUARE CROSSBAR)

KD-960LP / Polish

KD-960LB / Black

- 106cm L
- Maximum load 20 kg

KD-960MP / Polish

KD-960MB / Black

- 80cm L
- Maximum load 25 kg

KD-960MP-N / Polish

- 64cm L
- Maximum load 25 kg

KD-960QP / Polish

- 62cm L
- Maximum load 25 kg

KD-960SP / Polish

KD-960SB / Black

- 41cm L
- Maximum load 30 kg



- Requires 2 KD-900 , 2 KD-C05
- Thickness: 1cm
- Aluminum material



RECTANGULAR CROSSBAR FACEOUT

Designed for easy being mounted on the rectangular crossbar with the U-shaped mounting support.



KD-961P / Polish

KD-961B / Black

- 41cm L
- Maximum load 3 kg

KD-961SB / Black

- 30cm L
- Maximum load 3 kg

KD-961P-25 / Polish

- 25cm L
- Maximum load 3 kg

- For use with KD-960
- Thickness: 1cm
- Aluminum material



LAYER FACEOUT

Designed for easy being mounted on the rectangular crossbar with the U-shaped mounting support.



KD-962P / Polish

- 37cm L
- Thickness: 1cm
- Hold up to 8 hangers
- For use with KD-960
- Maximum load 3 kg
- Aluminum material



HANGER BAR

SPIRAL HANGER

The spiral rack allows pieces to be viewed from 360 degrees to attract customers to your latest fashions. 20 ball stops welded on the chrome plated spiral rack keep each hanger in place for an evenly spaced and balanced display. It can be also disassembled into 2 pieces for easy storage or transportation when needed.



KD-965P / Polish

- DIA. 2.5cm
- 75cm W x 90cm H
- Maximum load 20kg
- Requires 2 KD-900 or KD-C05
- Chrome-plated Steel



YouTube
KUPOLE FT.
SPIRAL HANGER



SPAN



- DIA. 3.5cm
- Requires 2 KD-900, KD-C05
- Aluminum material



KD-980LP / Polish KD-980LB / Black

- 106cm L
- Maximum load 20 kg

KD-980QP / Polish KD-980QB / Black

- 62cm L
- Maximum load 25 kg



YouTube
KUPOLE FT. HANGER BAR
(SPAN & HANGROD)

KD-980MP / Polish KD-980MB / Black

- 80cm L
- Maximum load 25 kg

KD-980SP / Polish KD-980SB / Black

- 41cm L
- Maximum load 30 kg



KD-981P / Polish KD-981B / Black Span with Hanger Stop

- 41cm L, DIA. 3.5cm
- Maximum load 4 kg
- Mounting on KD-900, KD-C05
- Aluminum material



KD-781P / Polish Faceout with Hanger Stop

- 41cm L, DIA. 3.5cm
- Maximum load 4 kg
- Mounting on KCP-700
- Aluminum material

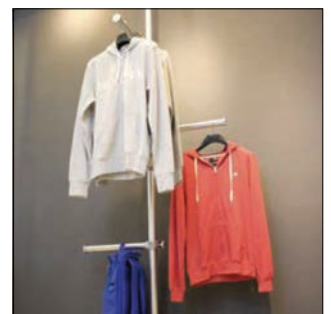

HANGER BAR

HANGROD



KD-985P / Polish

- 115cm W x 25.5cm D
- Requires 2 KD-900, 2 KD-C05
- Maximum load 20 kg
- Steel material

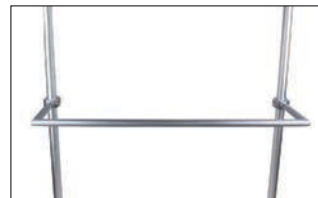

You Tube
KUPOLE FT. HANGER BAR
(SPAN & HANGROD)

SQUARE CROSSBAR



KD-PR30LP / Polish

- Adjustable from 105cm to 108cm
- Maximum load 15 kg

- 3cm Square
- Requires: 2 KD-900, 2 KD-C05



KD-PR30MP / Polish

- Adjustable from 80cm to 83cm
- Maximum load 20 kg

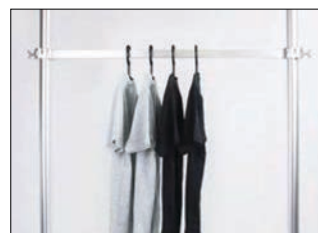

You Tube
KUPOLE FT. HANGER BAR
(RECTANGULAR & SQUARE CROSSBAR)

KD-PR30QP / Polish

- Adjustable from 61cm to 64cm
- Maximum load 20 kg

SQUARE FACEOUT



KD-PR31P / Polish

- 30.5cm L x 3cm Square
- Mounting on KD-900, KD-C05



You Tube
KUPOLE FT. HANGER BAR
(RECTANGULAR & SQUARE CROSSBAR)

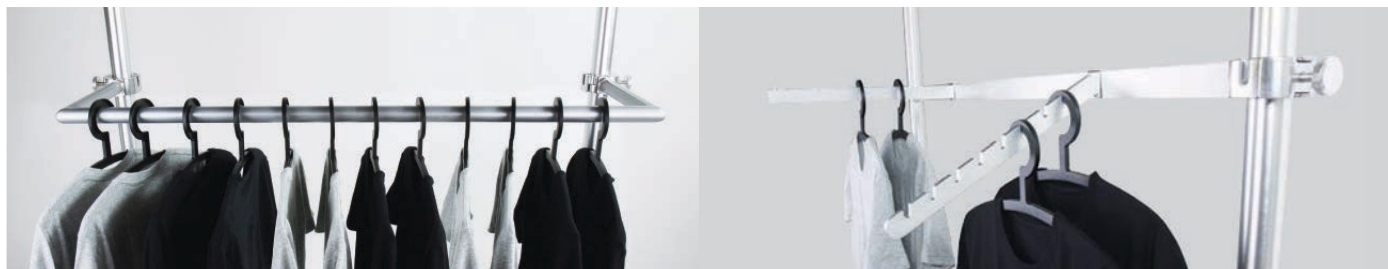

MIRROR HOLDER

Kupole mirror holder is a neat accessory for a rectangular or square mirror to hang on the pole. Easy and no complicated steps to build up. Just in 5-minute coffee break, you can create an elegant and spacious feeling to any space without breaking your wall.

KD-785P / Polish

MIRROR HOLDER



YouTube
MIRROR HOLDER
KD-785P



THE MIRROR MUST COME WITH THE WOODEN FRAME



1st Step:
Fasten the bars with Convi Clamp (KCP-700) by Allen wrench



2nd Step:
Clamp the bars on the Kupole



3rd Step:
Fix the clips with the wooden frame of the mirror



Final Step:
Place the mirror over the bar and slide it down



PROJECTOR HOLDER

KUPOLE

PROJECTOR MOUNT

Versatile, literally user-friendly, and like no others. This one-of-a-kind projector mount is fabricated with ball joint, providing 360 degree free movement for fine position adjustment and saving you much working time. Ratchet handle gives a positive and firm lock to fasten the position. The base is slotted with vortex pattern for maximum flexibility of accommodating diverse brands of projector.



KD-300 / Polish

- Weight: 1.05kg (2.31lbs)
- Maximum Load 15kg

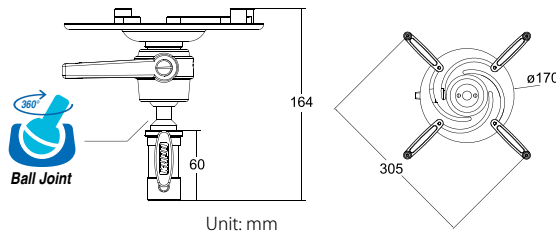

YouTube
UNIVERSAL
PROJECTOR MOUNT

SCREEN HOLDER

Kupole screen holder, a brilliant gadget giving a convenient manner to hang a video projector screen on the pole without too much effort. With this devices you can set up your own video demonstration or home theatre so quickly without breaking a brick.



KD-310P / Polish

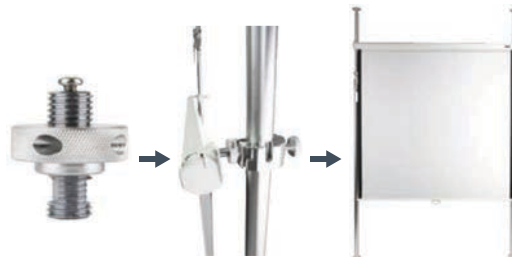

YouTube
KUPO SCREEN HOLDER
KD-310P

KS-094 / Polish Solid steel right angle stud

- Length: 19cm
- Attach Projector Mount to Kupole
- Mounting on KD-900, KD-C05



MONITOR HOLDER

LCD MONITOR ARM WITH CONNECTOR PLATE

Designed for mounting LCD monitor on tube size dia. 4-5cm with the steel clamp and wheel handle. VESA mount point 7.5x 7.5cm are drilled on the square black panel and 10 x 10cm is also available when fitted the standard accessory. Max loading weight: 8 KG (17.6lbs)



KD-M01P

- Fit VESA interface:
7.5cm x 7.5cm or 10cm x 10cm
- Mounts on Kupole
- Maximum load 8 kg



UNIVERSAL TV TILT MOUNT



KD-M02B

- Load Capacity: 30kgs
- Suitable for 37" to 52" flat TV screen
- Tilt Adjustment: 0-30 degree
(forward + backward)

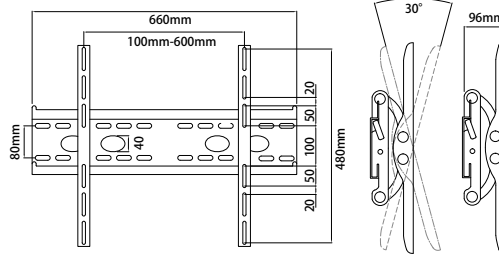

TABLET SECURITY HOLDER W/ LOCK

The protective case is constructed from tough ABS case & foam padding for impact resistance and protecting your tablet from bumps or scratches. Features a locking mechanism which can keep the case locked up with a 200cm (78") steel cable & PVC coated security cable allowing you to lock up your iPad anywhere that you can safely fasten it to while you step away. Ideal for offices, schools, dormitories and other public areas where you might take your iPad and leave it momentarily. It fits for iPad, iPad 2, iPad 3, iPad 4 and iPad Air (Adaptor brackets is required for iPad Air).



KS-550

- Case Size: 24.8 x 20 x 31 (cm)
- Weight: 290g (10.23oz)
- Lock cable: Dia. 4.4cm x L: 20 cm
- Fits VESA mount (75 x 75mm)



SALON HOLDER

KUPOLE

SWIVEL ARM



KD-937P / Polish

- 58cm L
- For mannequin head
- Attaches display head to KD-900, KD-C05



KD-737P / Polish

- 58cm L
- For mannequin head
- Attaches display head to KCP-700
- Weight: 0.86kg



KD-738W
Tiny Clamp with Swivel Arm

- Fit DIA.1.2cm to DIA.3.6cm tube & square plate thickness 1cm to 4.5cm
- For mannequin head
- Attaches display head to the table

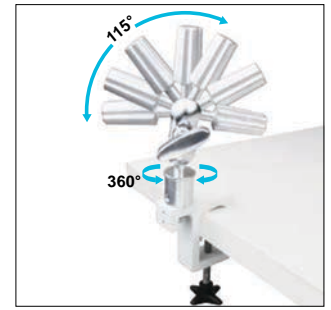

An ideal helper to hold the training head mannequin for the hairdressers or freshmen and also perfect display holder to show your hair design. Constructed with aluminum telescopic tube with steel made base offers a great solution to have a sufficient stability and easily adjust the height of head mannequin. Angle-adjusted arm terminated at the top of stand allows to position head mannequin anywhere you required. The unique leg locking system also makes it deploy and collapse with a snap and can be done within seconds by pulling spring ring and twist the stand.



KD-739P / Polish
C Stand for display head

- For mannequin head
- Height extends from 102.5cm to 142.5cm
- Upper tube DIA.3cm
- Lower tube DIA.3.5cm



YouTube
KUPO MASTER C-STAND
KD-739P

Demonstration of deploying Kupo turtle base C stand



Keep the legs up and pull up the spring ring.



Twist the stand and release the spring ring.



Completely setup after a snap deploying.



PATENTED

THE INNOVATIVE SPRING RING LOCKING SYSTEM DESIGN.

SALON HOLDER



SALON TOOL

This attractive black salon appliance holder series is made of the highest quality metal with a very contemporary hammered tone finish. All the holders are designed to be easily mounted on the pole system with donut (KD-900, sold separately). An ideal solution to organize or store your salon & hair appliances in one place.



KD-9101B / Black
Salon Tool Holder

- Plastic material



KD-9102B / Black
Salon Tool Holder with Power Outlet

- Plastic material



KD-9103B / Black
Salon Appliance Holder



KD-9104B / Black
Salon Appliance Holder with Power Outlet

KUBE

ACRYLIC SHELF

Made from heavy duty 8 mm thick acrylic, this shelf allows you to display an assortment of products in a neat and organized arrangement. All the acrylic curved shelves have pre-drilled holes which allows to be mounted on the pole with the holder (KD-K06P, sold separately). It also can be assembled as a Cube for free standing with connecting bar (KD-K45P, sold separately). An ideal solution for designing and creating all sorts of display acrylic shelf.



KD-K01C / Clear
KD-K01BL / Blue
Kube

- 44.5cm W x 40cm D x 43cm H
- Includes KD-K40, KD-K4037 and KD-K45 in one set

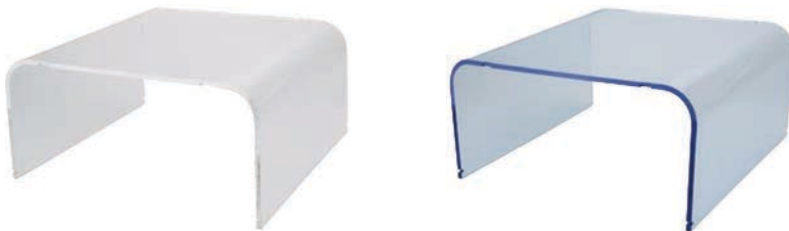

KD-K40C / Clear
KD-K40BL / Blue
Acrylic Curved Shelf

- Set of 2
- 0.8cm thick
- 40cm W x 40cm D x 19.6cm H

KD-K60C / Clear
KD-K60BL / Blue

- Set of 2
- 0.8cm thick
- 60cm W x 40cm D x 19.6cm H



KD-K4037C / Clear
KD-K4037BL / Blue
Acrylic Shelf

- 40cm W x 37cm L x 0.8cm thick

KD-K6037C / Clear
KD-K6037BL / Blue

- 40cm W x 57cm L x 0.8cm thick





KD-K06P / Polish Acylic Holder

- DIA. 6.2cm
- Attach Kube or Acrylic to KD-900, KD-C05
- Or Mounting on Pillar directly



KD-K15P / Clear Connecting Bars

- Set of 2
- Bar: 1.5cm W x 40cm L x 3cm H
- Clip: 1.5cm W x 4.5cm H
- Used to clamp 2 Kubes in vertical



KD-K16P / Clear Kube Base Bars

- Set of 2
- Bar: 1.5cm W x 40cm L x 3cm H
- Clip: 1.5cm W x 3.8cm H

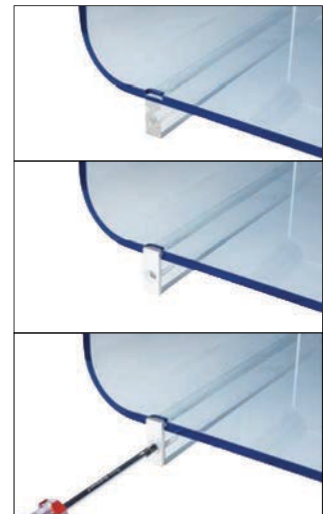

KD-K45P Bar with 8 Channels

- Set of 2
- DIA. 4.5cm, 40cm L
- Accepts material up to 0.8cm thick

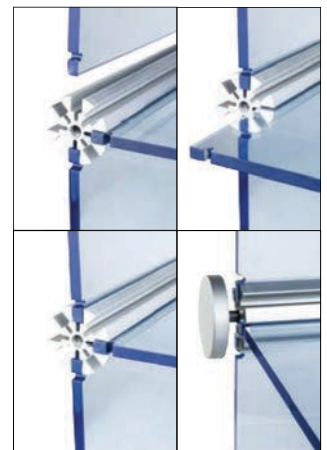

SPORT FIXTURE



YouTube
KUPOLE FT.
BICYCLE WHEEL HOLDER

The chrome plated steel wheel holder can hold your wheel securely on the pole in place. Perfect for pick-up and storage for your bicycle wheel.



KD-932P / Polish Wheel Holder

- 11 cm W x 3.5cm D
- Mounting on KD-900, KD-C05



YouTube
KUPOLE FT.
VERTICAL BICYCLE STORAGE

The vertical bike rack constructed from solid steel comes with anti-slip treads helps keep bike firmly in place on the pole. The rubber coating on hook ensures your bike will not get scratched when loading or unloading. additional U hook ensure the lower wheel attached on the pole securely.



KD-934P / Black Vertical Bicycle Fixture

- Mounting on KD-900, KD-C05
- Maximum load 15kg



SPORT FIXTURE



This metal made bike fixture features an angle-adjustable locking system which allows to keep bike in three different position. The mobility of hooks allows to fit for all bike size and frame styles. The hanging cradles are coated in soft plastic to prevent scuffs and other damage. It has to be mounted on the pole with Donut (KD-900 included) to keep your bike off ground.



KD-935P / Polish Bicycle Fixture

- 42cm W x 12.7cm D x 11.6cm H
- Mounting on KD-900, KD-C05
- Maximum load 15 kg



Upward

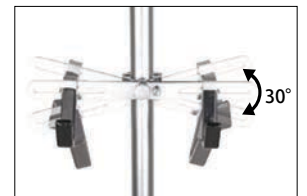

This solid steel mead with superior powder coated rack is specially designed for hanging a scooter on the pole effortlessly.



KD-734B / Black Scooter Rack

- 8cm x 15cm
- Mounting on KCP-700
- Maximum load 5 kg



SPACE ORGANIZER

SPORTS GEAR RACK



BRILLIANT SPACE ORGANIZER EXCLUSIVE FOR SPORTS GEAR

Constructed from rugged steel with elegant powder coating surface treatment, this steel Kupole provides an ideal storage solution specially for household and garage.



One way clamp | Vertical Surfboard Rack | Horizontal Surfboard Rack | Pair Surfboard Rack
Hanger Holder | Tennis Rack | Kayak Rack | Steel Hook | Steel Faceout | Fishing Rod Rack

ONE WAY CLAMP

Constructed from rugged steel with elegant powder coating surface treatment, this one way clamp equipped with magnetic brake pad is built for directly attaching on the steel Kupole with ease and comfort. The recessed mounting location allows to accept a series of interchangeable accessories.



KD-400

- Clamp tubes from DIA. 4cm to 4.5cm
- Magnetic brake with rubber pad grasps onto the steel Kupole firmly without slip-off.

KPS-L2137GC / Gray Steel Kupole with curvy handle

- Height extends from 210cm to 370cm
- Upper tube DIA. 4cm
- Lower tube DIA. 4.5cm



YouTube

SPORT GEAR RACK
400 SERIES

SPACE ORGANIZER



KD-410 Vertical Surfboard Rack

- Mounting on KD-400
- Also fit for skateboard, etc.
- Maximum load 15kg

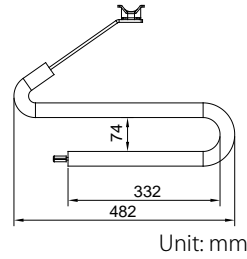

KD-411 Horizontal Surfboard Rack

- 9 adjustable positions, Every 15 degree.
- Mounting on KD-400
- Also fit for snowboard, skateboard, etc.
- Maximum load 10kg

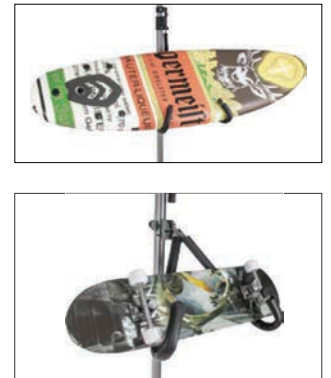
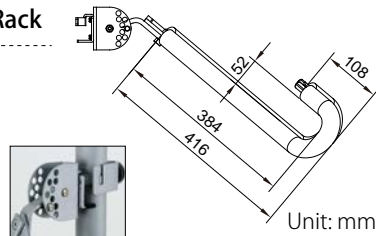

KD-412 Pair Surfboard Rack (Set of 2)

- For Horizontal use
- 9 adjustable positions, Every 15 degree.
- Mounting on KD-400
- Requires 2 Kupoles / Gyro-poles
- Also fit for snowboard, skateboard, etc.
- Maximum load 15kg

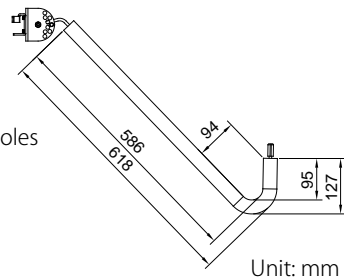

KD-470 Kayak Rack (Set of 2)

- Mounting on KD-400
- Requires 2 Kupoles / Gyro-poles
- Maximum load 50kg

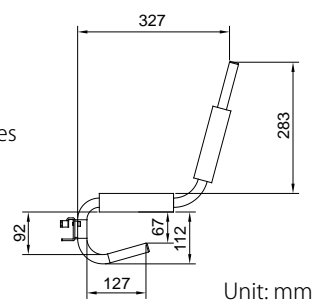

SPACE ORGANIZER



KD-441
Fishing Rod Rack

- Hold for 5 Fishing Rods
- 9 adjustable positions, Every 15 degree.
- Mounting on KD-400
- Maximum load 8kg

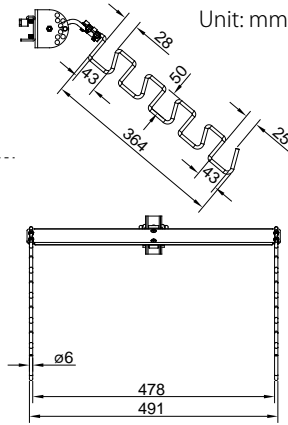

KD-442
Pair Fishing Rod Rack (Set of 2)

- Hold for 5 Fishing Rods
- 9 adjustable positions, Every 15 degree.
- Mounting on KD-400
- Requires 2 Kupoles / Gyro-poles
- Maximum load 8kg

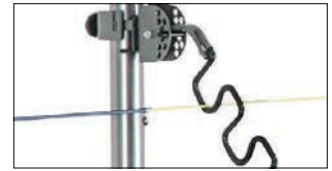
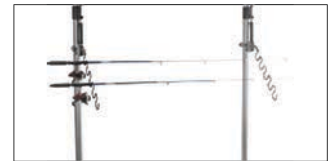
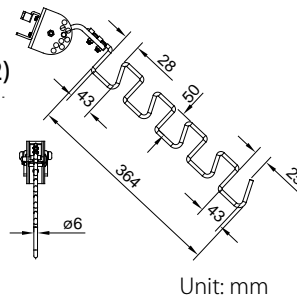

KD-A001
Steel Hook

- For Tube DIA. 4cm
- Maximum load 8kg

KD-A002
Steel Hook

- For Tube DIA. 4.5cm
- Maximum load 8kg

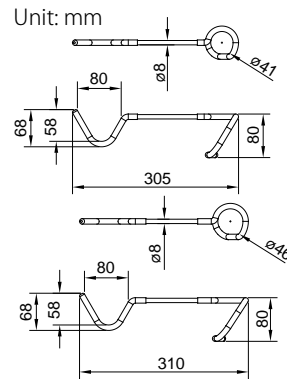

KD-A003
Steel Faceout

- For Tube DIA. 4cm
- Maximum load 8kg

KD-A004
Steel Faceout

- For Tube DIA. 4.5cm
- Maximum load 8kg

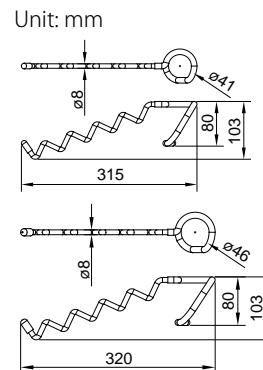

SPACE ORGANIZER



YouTube

KUPOLE FT.
GUITAR HOLDER
KD-A005 & KD-A006



KD-A005 Guitar Holder

- For Tub DIA. 4cm
- Maximum load 8kg

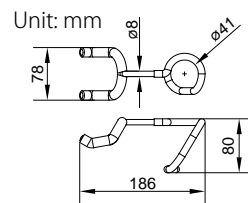

KD-A006 Guitar Holder

- For Tub DIA. 4.5cm
- Maximum load 8kg

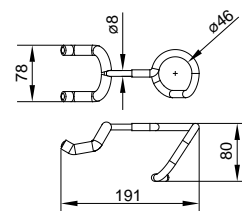

KD-420 Hanger Holder (Set of 2)

- Fit for DIA. 2.5cm Tube (not include)
- Mounting on KD-400
- Requires 2 Kupoles / Gyro-poles
- Maximum load 15kg

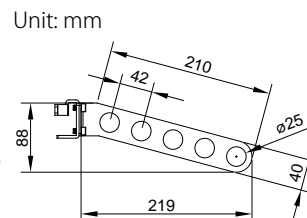

MISCELLANEA

BUBBLE LEVEL

The leveler comes with the flexible rubber segregated latch for easily wrapping around any pole from 1" (25.4cm) to 2" (50mm) in diameter and locks into place in seconds. The integrated bubble helps to determine if the pole get upright position for backgrounds or display.



KD-B003
Bubble Spirit Level w/a
Rubber Segregated Latch

- Accept cable O.D. 0.6cm or 1cm
- Clip tubes from 4cm-4.5cm
- Transparent color



OWL CABLE CLIPS

Owl cable clips are designed to hold the power cable along with the lighting stand or a round tube. It is made of durable, flexible, one piece injection PC, molded with a low-key transparent finish. The cable clips accommodate two O.D. 10 mm and one O.D. 6.5 mm wires throughout. Reusable and easy to mount onto 40-50 mm tubes with one hand. Allows organizing and routing wires in any way you want. Standard package is 4 units per bag.

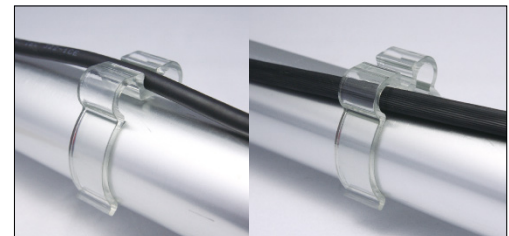

KD-C40P
Owl Clip

- Set of 4
- Accept cable O.D. 0.6cm or 1cm
- Clip tubes from 4cm-4.5cm
- Transparent color



KD-C25P
Owlet Clip

- Set of 4
- Accept cable O.D. 0.6cm or 1cm
- Clip tubes from 2.5cm-3.5cm
- Transparent color

SECURITY COLLAR

Security collar activates as secondary safety holder for Kupole, preventing the upper tube (DIA. 4cm) from sliding down and increasing the payload capacity. Add this collar to the Kupole and feel the peace of mind in operation.



You Tube
SECURITY COLLAR



KD-B005P / Polish

- Clamp tube DIA. 4cm



KUPOLE FINIAL Fits on top of Kupole when not tension mounted



KD-F50P

- For Tube DIA. 4cm

KD-F51P

- For Tube DIA. 4.5cm



KD-R46P
Kupole Ceiling Mount

- DIA. 8cm
- Attaches Kupole to the solid ceiling



KD-R47P
Kupole Floor Mount

- DIA. 8cm
- Attaches Kupole to the solid floor



KUPOLE FT. CEILING & FLOOR MOUNT



KD-R48P-B
Disc Base Adapter

- Attaches Base to Kupole



KD-R48P
Kupole Disc Base With Adapter

- DIA. 48.3cm Steel Base for Kupole



KUPOLE FT. FREESTANDING ROUND BASE

This is a sturdy 19" (48.3 cm) diameter and weight 12KG round metal base for Kupole. Use them for a clean streamlined look and ideal for visual merchandizing or displays.



KD-F95P
Kupole Female Socket

- For tube DIA. 4cm
- Mounts on top of Kupole when it is not tension mounted
- Insert accessories into socket on top



MISCELLANEA



KD-CM16P
Ceiling Clip with Male Adapter

- Attach accessories to typical suspended type ceiling



KD-CF16P
Ceiling Clip with Female Socket

- Attach accessories to typical suspended type ceiling



KD-C50P
Kupole Suspended Ceiling Adapter

- Attaches Kupole to typical suspended type ceiling



YouTube
**KUPOLE SUSPENDED
CEILING ADAPTER**



KD-T50P
Kupole Coupler

- Attaches Kupole to fit tube with diameter between 4.8cm to 5.1cm
- It connects the kupole with the truss
- Weight: 0.55 kg



KD-TM10
Screw

- M10: 2.8cm (L)
- 1/4-20 thread: 0.5cm (L)
- For Span joint





**KD-980WSP / Polish
Span Wall Mount**

- DIA. 3.5cm
- 20cm L
- Mounting on KD-900, KD-C05 to wall



**KD-982P / Polish
Wall Mount**

- DIA. 3cm
- Attaches KD-980 to ceilings or wall



**KD-PR50P / Polish
Pillar Wall Mount**

- Set of 2
- 25.5cm L
- Mounting on KD-900, KD-C05 to wall



**KD-B126P / Polish
Kupole Tripod Base**

The Kupole base is designed to convert Kupole to conventional stand whenever the ceiling is higher than 12' (3.6M) or a free-standing background is needed. The center base accepts 45mm diameter tubes. Leg diameter: 22mm with 49.6 (126cm) footprint. Just remove the bottom rubber cover, slide on tripod base then replace the cover.

- Footprint DIA. 126cm



With Kupole

SUPER JOINT



SUPER JOINT

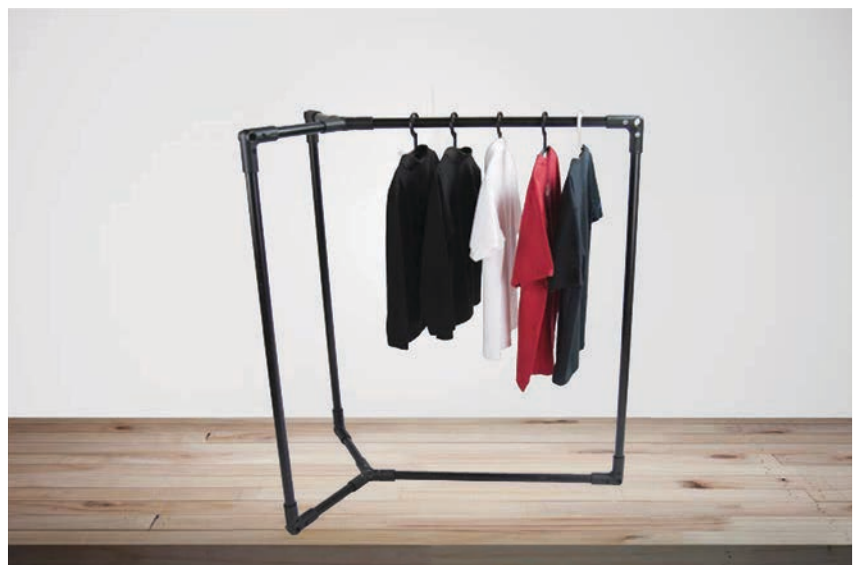
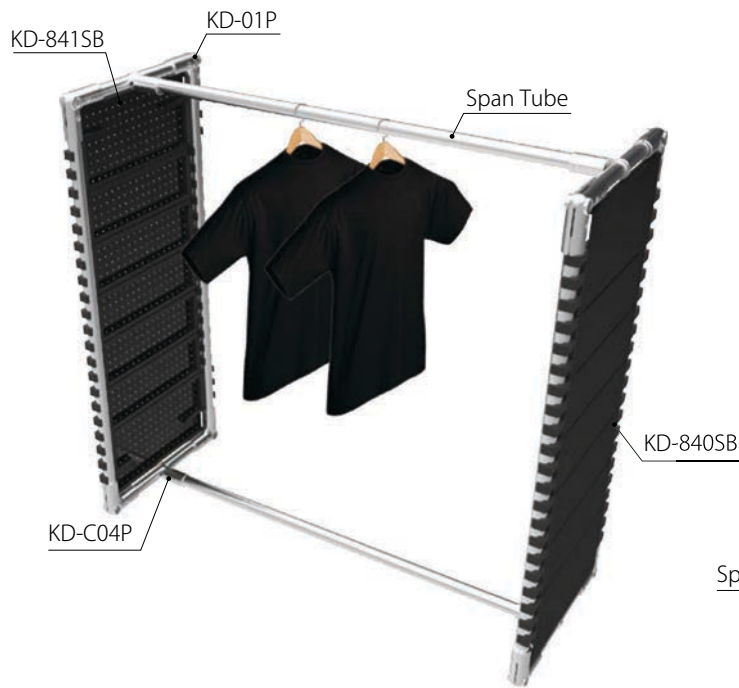

SUPER JOINT

SUPER JOINT

This super joint series is extreme flexible and ease of assemble by the modular system of tubes and casting clamps that allows you to design and create all sorts of display structure. It is easy to set up and disassemble with a standard Allen Wrench to provide a fast and re-usable display structure. The standard tube is measured 35mm in diameter and available in four lengths including 50cm, 100cm, 150cm and 200cm.

Y- ISLAND

- Steel Tube with Aluminum Joints
- Freestanding unit as Floor Fixtures
- Finishing: Black Painted



You Tube
SUPER JOINT SYSTEM
Y-ISLAND



KD-C1412B / Black
Super Joint Y island

- Size: 120cm L x 72cm W x 140cm H

KD-C1414B / Black
Super Joint Double Y island

- Size: 140cm L x 72cm W x 140cm H



ACCESSORY

CURVED CLAMP



KD-C01P / Polish **KD-C01B** / Black

- Fits with Span Tube (DIA.3.5cm)

2 WAY JOINT



KD-C02P / Polish **KD-C02B** / Black

- Fits with Span Tube (DIA.3.5cm)

JOINT WITH SCREW



KD-C03P / Polish **KD-C03B** / Black

- Fits with Span Tube (DIA.3.5cm) and attaches to KD-C01 or KD-C02 for more application.

VARIABLE ANGLE JOINT



KD-C04P / Polish **KD-C04B** / Black

- Fits with Span Tube (DIA.3.5cm)

MINI DONUT



KD-C05P / Polish **KD-C05B** / Black

- Fits with Span Tube (DIA.3.5cm)
- Attaches up to 3 accessories to tube

Y CONNECTOR



KD-C06P / Polish **KD-C06B** / Black

- Fits with Span Tube (DIA.3.5cm)

ACCESSORY

FOOT ADAPTER



KD-C07P / Polish

- Inserts into Span Tube (DIA. 3.5cm) to attaches caster (M10 x 30mm)

FOOT ADAPTER



KD-C07P-C / Polish **KD-C07B-C** / Black

- Inserts into KD-C01~KD-C06 to attaches caster (M10 x 1.5cm)

CASTER ADAPTER



KD-C08P / Polish **KD-C08B** / Black

- Fit with Span Tube (DIA. 3.5cm) and attaches cater (M10 x 1.5cm)
- Without caster

CASTER



KC-080-C

- Set of three
- DIA. 7.5cm w/brakes and M10 attachment (1.5cm length)

BASE FLANGE



KD-C09P / Polish **KD-C09B** / Black

- Plate DIA. 8cm
- Inserts into Span Tube (DIA. 3.5cm)
- Attaches Super Joint System to the solid floor



YouTube
SUPER JOINT
ACCESSORIES



TUBE & PANEL



- DIA. 3.5cm, T: 1.0mm
- Aluminum material

KD-C0500P / Polish
KD-C0500B / Black

- 50cm L

KD-C1000P / Polish
KD-C1000B / Black

- 100cm L

KD-C1500P / Polish
KD-C1500B / Black

- 150cm L

KD-C2000P / Polish
KD-C2000B / Black

- 200cm L

- DIA. 3.5cm, T: 1.5mm
- Steel material

KD-CS0500P / Polish
KD-CS0500B / Black

- 50cm L

KD-CS1000P / Polish
KD-CS1000B / Black

- 100cm L

KD-CS1500P / Polish
KD-CS1500B / Black

- 150cm L

KD-CS2000P / Polish
KD-CS2000B / Black

- 200cm L

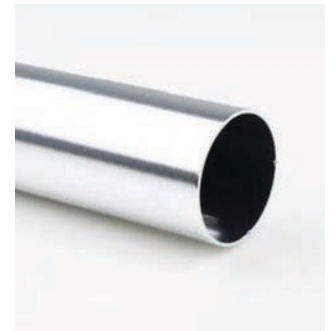

SUPER JOINT

PANEL WITH HOLES

15cm W x 1.86cm D



KD-840LB / Black

- 108cm L

KD-840MB / Black

- 82.5cm L

KD-840SB / Black

- 44cm L

PANEL

15cm W x 1.86cm D



KD-841LB / Black

- 108cm L

KD-841MB / Black

- 82.5cm L

KD-841SB / Black

- 44cm L

EXTENSION PANEL WITH HOLES

22cm W x 1.86cm D



KD-842LB / Black

- 108cm L

KD-842MB / Black

- 82.5cm L

KD-842SB / Black

- 44cm L

EXTENSION PANEL

22cm W x 1.86cm D



KD-843LB / Black

- 108cm L

KD-843MB / Black

- 82.5cm L

KD-843SB / Black

- 44cm L



- Mounting on DIA. 3.5cm tube

PIPE CLAMP



PIPE CLAMP



PIPE CLAMP

PIPE CLAMP

ALUMINUM-MAGNESIUM ALLOY SLIP-ON PIPE CLAMP

Made of A535 aluminum alloy, the aluminum slip-on clamps features high strength, corrosion resistance, and lightweight. Polished finish keeps the surface bright and attractive, and the aluminum-magnesium alloy makes the clamps extremely durable, tough, lighter than the iron clamp, and require little long-term maintenance. Flexible, versatile and rigid. Designed for well-known Schedule 40 pipe. Suitable for a wide variety of tubular applications and structures such as film industry, amusement park, playground, recreational venue, contemporary store and restaurant, industrial guardrails, display, shopfitting and much more.

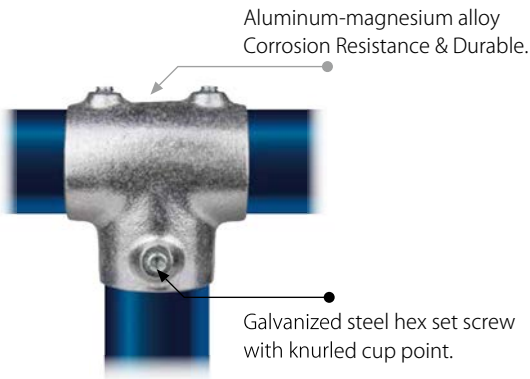

Feature:

- Lightweight and corrosion resistance, ideal for outdoor or harsh environment
- Quick and easy installation with a standard hex key, no special tools required
- No welding; no specialist labor required
- Fitting with 3/8" galvanized steel recessed grub screw with reverse knurled cup point
- Tapered-dome design for holding the set screws over their entire length
- Suitable for Schedule 40 nominal pipe 1-1/4" and 1-1/2"



YouTube
KUPU MALLEABLE
IRON CASTING PIPE CLAMPS
(FULL FOOTAGE)



YouTube
KUPU MALLEABLE
IRON CASTING PIPE CLAMPS
(PRODUCT CODE)

Subject to aluminum casting manufacturing, dimension might slightly differ in each production.
The dimensions given are nominal value for reference only

90 DEGREE

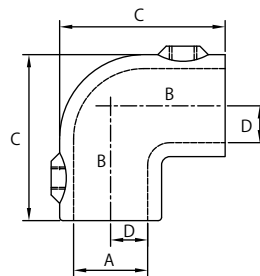

KPC-A1203 | For tube O.D. 48.30mm (1.90")
KPC-A1403 | For tube O.D. 42.40mm (1.66")

A [mm]	B [mm]	C [mm]	D [mm]
50.2	59	94	25
44	51	83	22

ADJUSTABLE ELBOW

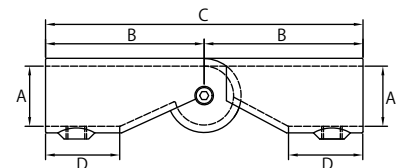

KPC-A1203AE | For tube O.D. 48.30mm (1.90")
KPC-A1403AE | For tube O.D. 42.40mm (1.66")

A [mm]	B [mm]	C [mm]	D [mm]	Minimum corner
50.2	114	228	41	42 degree
44	97	194	41	

LONG TEE

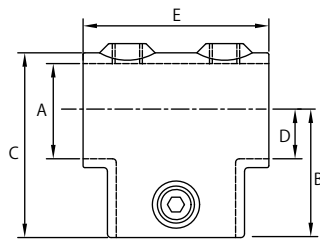

KPC-A1205 | For tube O.D. 48.30mm (1.90")
KPC-A1405 | For tube O.D. 42.40mm (1.66")

A [mm]	B [mm]	C [mm]	D [mm]	E [mm]
50.2	59	94	25	86
44	51	83	22	70

SHORT TEE

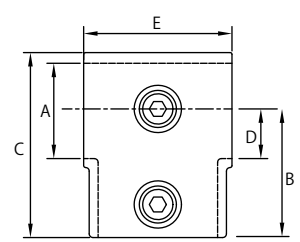

KPC-A1205E | For tube O.D. 48.30mm (1.90")
KPC-A1405E | For tube O.D. 42.40mm (1.66")

A [mm]	B [mm]	C [mm]	D [mm]	E [mm]
50.2	57	87.5	25	64
44	51	78	22	57

PIPE CLAMP

TWO SOCKET CROSS

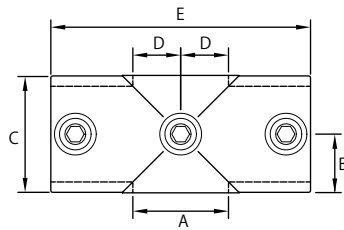

KPC-A1207E | For tube O.D. 48.30mm (1.90")
KPC-A1407E | For tube O.D. 42.40mm (1.66")

A [mm]	B [mm]	C [mm]	D [mm]	E [mm]
50.2	30.5	61	25	113
44	26.5	53	22	102

3 WAY 90 DEGREE

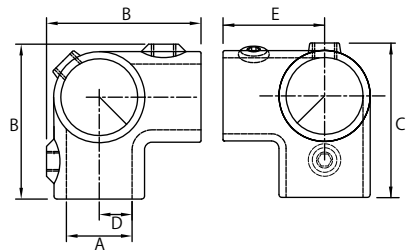

KPC-A1209 | For tube O.D. 48.30mm (1.90")
KPC-A1409 | For tube O.D. 42.40mm (1.66")

A [mm]	B [mm]	C [mm]	D [mm]	E [mm]
50.2	94	94	25	59
44	83	83	22	52

CORNER

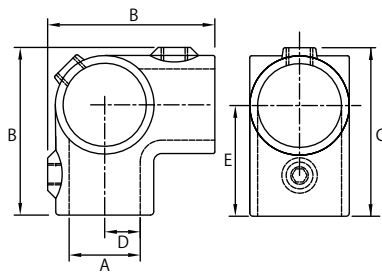

KPC-A1211E | For tube O.D. 48.30mm (1.90")
KPC-A1411E | For tube O.D. 42.40mm (1.66")

A [mm]	B [mm]	C [mm]	D [mm]	E [mm]
50.2	94	94	25	59
44	83	83	22	52

90 DEGREE CROSSOVER

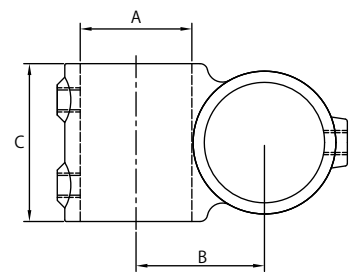

KPC-A1212 | For tube O.D. 48.30mm (1.90")
KPC-A1412 | For tube O.D. 42.40mm (1.66")

A [mm]	B [mm]	C [mm]
50.2	52	63.5
44	45	56.5

ADJUSTABLE ELBOW OR TEE

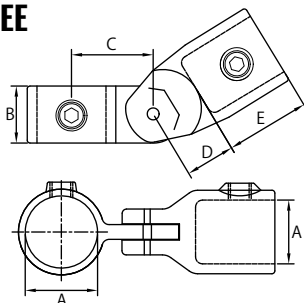

KPC-A1217E | For tube O.D. 48.30mm (1.90")
KPC-A1417E | For tube O.D. 42.40mm (1.66")

A [mm]	B [mm]	C [mm]	D [mm]	E [mm]
50.2	38	57	28.5	44
44	38.5	52	29	42

MALE TAB OF SWIVEL

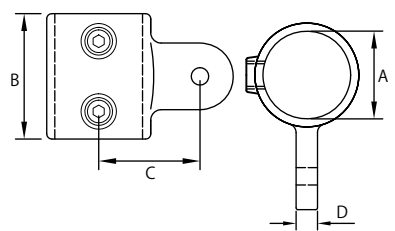

KPC-A1217M | For tube O.D. 48.30mm (1.90")
KPC-A1417M | For tube O.D. 42.40mm (1.66")

A [mm]	B [mm]	C [mm]	D [mm]
50.2	70	55	12
44	60	52	11

PIPE CLAMP

SWIVEL ELBOW / TEE

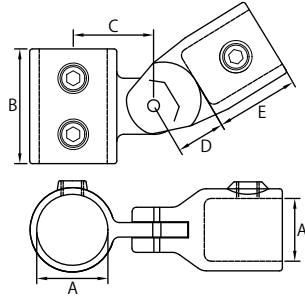

KPC-A1217ADJ | For tube O.D. 48.30mm (1.90")
KPC-A1417ADJ | For tube O.D. 42.40mm (1.66")

A [mm]	B [mm]	C [mm]	D [mm]	E [mm]
50.2	70	57	28.5	44
44	60	52	29	42

DOUBLE SWIVEL COMBINATION

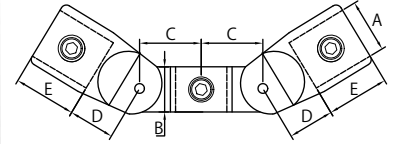

KPC-A1219E | For tube O.D. 48.30mm (1.90")

A [mm]	B [mm]	C [mm]	D [mm]	E [mm]
50.2	39	57	28.5	44

DOUBLE SWIVEL COMBINATION

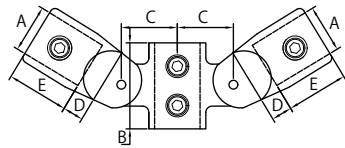

KPC-A1419E | For tube O.D. 42.40mm (1.66")

A [mm]	B [mm]	C [mm]	D [mm]	E [mm]
44	70	49	29	42

SHORT TEE SWIVEL

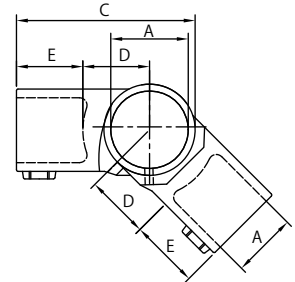

KPC-A1230C | For tube O.D. 48.30mm (1.90")
KPC-A1430C | For tube O.D. 42.40mm (1.66")

A [mm]	B [mm]	C [mm]	D [mm]	E [mm]
50.2	62	111	38	42
44	54	100	35	36

ROUND BASE FLANGE

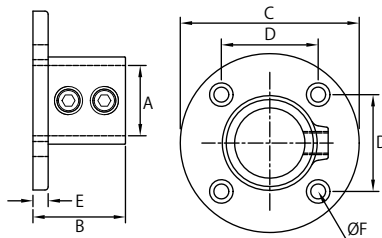

KPC-A1242 | For tube O.D. 48.30mm (1.90")
KPC-A1442 | For tube O.D. 42.40mm (1.66")

A [mm]	B [mm]	C [mm]	D [mm]	E [mm]	F [mm]
50.2	58	114	64	10	11
44	57	114	64	10	11

RAILING BASE FLANGE

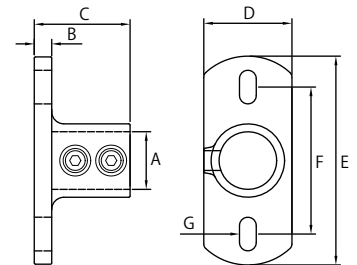

KPC-A1246 | For tube O.D. 48.30mm (1.90")
KPC-A1446 | For tube O.D. 42.40mm (1.66")

A [mm]	B [mm]	C [mm]	D [mm]	E [mm]	F [mm]	G [mm]
50.2	15	77	71	155	107.5	13.5 x 20.5
44	10	56	63.5	146.5	107.5	15 x 24

PIPE CLAMP

ADJUSTABLE FLANGE

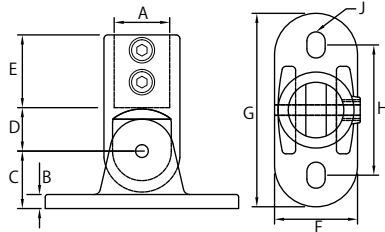

KPC-A1246ADJ | For tube O.D. 48.30mm (1.90")
KPC-A1446ADJ | For tube O.D. 42.40mm (1.66")

A	B	C	D	E	F	G	H	J
[mm]	[mm]	[mm]	[mm]	[mm]	[mm]	[mm]	[mm]	[mm]
50.2	11	43	37	57	67	153	102	14 x 21
44	11	43	36.5	58	66	152	102	14 x 21

SIDE PALM FIXING

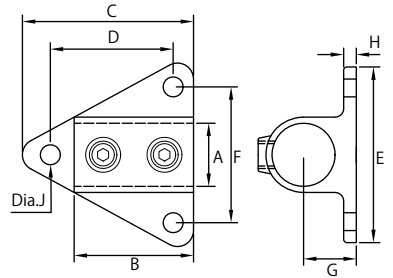

KPC-A1250 | For tube O.D. 48.30mm (1.90")
KPC-A1450 | For tube O.D. 42.40mm (1.66")

A	B	C	D	E	F	G	H	J
[mm]	[mm]	[mm]	[mm]	[mm]	[mm]	[mm]	[mm]	[mm]
50.2	74	114	83	114	83	35	8.5	11
44	62	99	67	108	76	35	8	11

PLUG

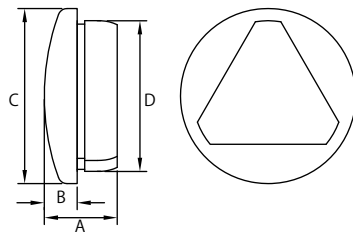
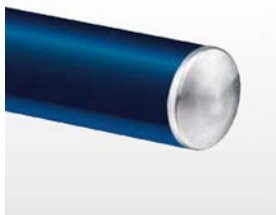

KPC-A1262 | For tube O.D. 48.30mm (1.90")
KPC-A1462 | For tube O.D. 42.40mm (1.66")

A	B	C	D
[mm]	[mm]	[mm]	[mm]
20	9	48	41.3
19.3	8.3	42	35.3

SLEEVE JOINT

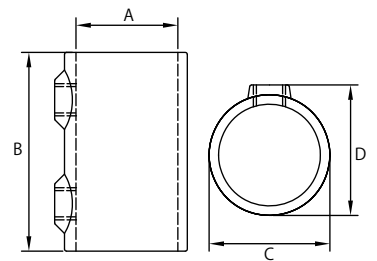

KPC-A1270 | For tube O.D. 48.30mm (1.90")
KPC-A1470 | For tube O.D. 42.40mm (1.66")

A	B	C	D
[mm]	[mm]	[mm]	[mm]
50.2	89	61	66
44	88	53	58

HANDRAIL BRACKET

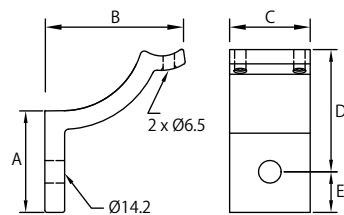

KPC-A1282A | For tube O.D. 48.30mm (1.90")

A	B	C	D	E
[mm]	[mm]	[mm]	[mm]	[mm]
66	76	51	79	24

APPLICATION



X-BONE



KXB-6-20
20cm X-BONE

- Weight: 2.1kg
- Fold: 11.5cm L x 7.5cm W x 58cm H
- Unfold: 120cm L x 60cm W x 20cm H



KXB-6-40
40cm X-BONE

- Weight: 2.9kg
- Fold: 11.5cm L x 7.5cm W x 68cm H
- Unfold: 120cm L x 60cm W x 40cm H



KXB-6-60
60cm X-BONE

- Weight: 3.5kg
- Fold: 11.5cm L x 7.5cm W x 81cm H
- Unfold: 120cm L x 60cm W x 60cm H



KXB-6-80
80cm X-BONE

- Weight: 4.7kg
- Fold: 11.5cm L x 7.5cm W x 96.5cm H
- Unfold: 120cm L x 60cm W x 80cm H



KXB-6-100
100cm X-BONE

- Weight: 5.1kg
- Fold: 11.5cm L x 7.5cm W x 148cm H
- Unfold: 120cm L x 60cm W x 100cm H



KXB-FP
Plastic Foot Pad



KXB-AK
Accessory Kit

KUPO X-Bone is an ideal solution for needs on the move, featuring light weight, compact and durable. The patent structure makes it easy to fold and unfold in minutes, and aluminum alloy makes it light but sturdy for frequent usage. Six models with different heights creates versatile display and applications.

X-BONE

Features:

- (1) made of high intensity aluminum alloy (6061), enduring deformation and load for 4.8 -5.0 tons/square meter.
- (2) compact, light weight, easy to build up and break down in around two minutes per set; needless space to archive.
- (3) stylish and slim profile; treated with anodized coating for rust-free.
- (4) different sizes make flexible applications accessible.

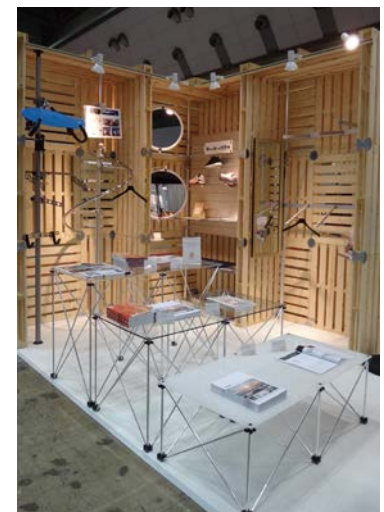
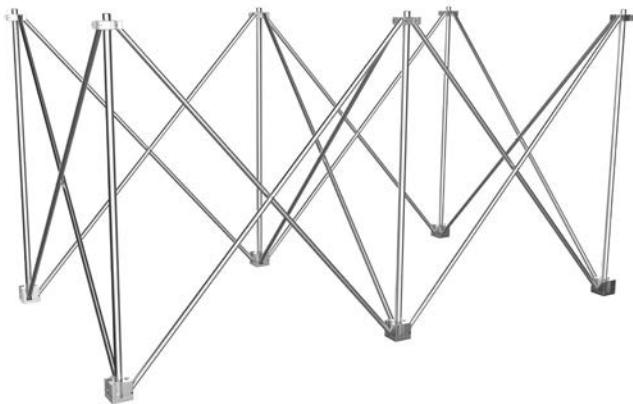

INDEX

Code	Description	Page	Code	Description	Page
KCP-350B	Mini Ali Clamp - Black	32	KD-601P	Vivi-Ring with M6 female thread	23
KCP-350P	Mini Ali Clamp - Polish	32	KD-602P	Vivi-Ring with Hanger Rod	24
KCP-360B	Ali Clamp - Black	32	KD-603P	Vivi-Ring with Slim Rod	24
KCP-360P	Ali Clamp - Polish	32	KD-604P	Bicycle Helmet holder	24
KCP-700B	Convi Clamp - Black	22	KD-650W	Kupole Round Table, DIA. 60cm	25
KCP-700P	Convi Clamp - Silver	22	KD-655P	Holding Ring for KD-650W	24
KD-0730B	Mini Ali Clamp with Stud (KCP-350B+KS-017) - Black	32	KD-710B	Panel Holder - Black	29
KD-0730P	Mini Ali Clamp with Stud (KCP-350P+KS-017) - Polish	32	KD-710P	Panel Holder - Polish	29
KD-0731B	Ali Clamp with Stud (KCP-360B+KS-017) - Black	32	KD-710P-C	Panel Holder (1.0cm) - Polish	29
KD-0731P	Ali Clamp with Stud (KCP-360P+KS-017) - Polish	32	KD-712P	Panel Holder (1.2cm) - Polish	29
KD-0732B	Mini Ali Clamp with Stud (KCP-350B+KS-020) - Black	33	KD-720B	Panel Holder with set screws - Black	29
KD-0732P	Mini Ali Clamp with Stud (KCP-350P+KS-020) - Polish	33	KD-720P	Panel Holder with set screws - Polish	29
KD-0733B	Ali Clamp with Stud (KCP-360B+KS-020) - Black	33	KD-730B	Socket - Black	29
KD-0733P	Ali Clamp with Stud (KCP-360P+KS-020) - Polish	33	KD-730P	Socket - Polish	29
KD-080-C	Caster (Set of 3)	66	KD-734B	Scooter Rack	52
KD-0930P	Curved Frame	34	KD-735P	Mini Flex Arm with Clip, 23cm L	35
KD-300	Projector Mount	46	KD-737P	Swivel Arm, 58cm L For model's head	48
KD-310P	Screen Holder	46	KD-738W	Tiny Clamp with Swivel Arm - White	48
KD-400	One way clamp	23, 52	KD-739P	C stand - For model's head	48
KD-410	Vertical Surfboard Rack	55	KD-740P	Display Shelf, 38cm square	38
KD-411	Horizontal Surfboard Rack	55	KD-740P-A	Holding Arm, 37cm L	38
KD-412	Pair Surfboard Rack (Set of 2)	55	KD-741LP-S	Shelf with Bent Edges (101cm)	40
KD-420	Hanger Holder (Set of 2)	57	KD-741P	Shelf with Bent Edges (76cm)	40
KD-441	Fishing Rod Rack	56	KD-742P	Book Shelf	41
KD-442	Pair Fishing Rod Rack (Set of 2)	56	KD-743P	Catalogue Shelf	41
KD-470	Kayak Rack (Set of 2)	55	KD-747P	Round Shelf, DIA. 33cm	38
KD-500DP	Aluminum Double Sided Slat Panel	26	KD-751P	Sign frame Tripod/Ceiling	37
KD-500P	Aluminum Slat Panel	26	KD-752P	Sign frame Tripod/Ceiling	37
KD-501P	LOGO Holder Without Panel (Set of 4)	27	KD-753P	Sign Frame with Base	37
KD-502P	Shoe Panel	27	KD-760SP	Banner Rod with Stud, 61cm L	35
KD-503P	Display Shelf, 30cm x 45cm	27	KD-760TP	Banner Rod with Thread, 61cm L	35
KD-600P	Vivi-Ring with M10 female thread	23	KD-770P	Display Box	39
			KD-770P-A	Holding Arm, 29cm L	38
			KD-771P	Shelf with Bent Edges	39
			KD-772P	Box Shelves	40
			KD-781P	Faceout with Hanger Stop, 41cm L	43
			KD-785P	Mirror Holder	45
			KD-790B	L Bracket Shelf Holder, Set of 2 - Black	30
			KD-790P	L Bracket Shelf Holder, Set of 2 - Polish	30
			KD-795B	Compact U Hook - Black	31

INDEX

Code	Description	Page	Code	Description	Page
KD-795P	Compact U Hook - Polish	31	KD-915P-2CM	Tidy Panel Holder (2cm) - Polish	30
KD-800P	Telescopic Signholder	33	KD-920B	Rotating Panel Holder - Black	28
KD-812B	U Hook - Black	31	KD-920P	Rotating Panel Holder - Polish	28
KD-812P	U Hook - Polish	31	KD-932P	Wheel Holder - Polish	52
KD-813B	Compact U Hook - Black	31	KD-934P	Vertical Bicycle Fixture	52
KD-813P	Compact U Hook - Polish	31	KD-935P	Bicycle Fixture with Dount	53
KD-815P	Vase Holder	31	KD-937P	Swivel Arm, 58cm L For model's head	48
KD-816B	Square Clip - Black	34	KD-940P	Display Shelf, 38cm square	38
KD-816P	Square Clip - Polish	34	KD-940P-A	Holding Arm, 37cm L	38
KD-817P	Screen Holder	34	KD-942P	Book Shelf	41
KD-840LB	Panel with Holes, 108cm L	67	KD-943P	Catalogue Shelf	41
KD-840MB	Panel with Holes, 82.5cm L	67	KD-947P	Round Shelf, DIA. 33cm	38
KD-840SB	Panel with Holes, 44cm L	67	KD-960LB	Rectangular Crossbar, 106cm L - Black	42
KD-841LB	Panel, 108cm L	67	KD-960LP	Rectangular Crossbar, 106cm L - Polish	42
KD-841MB	Panel, 82.5cm L	67	KD-960MB	Rectangular Crossbar, 80cmL - Black	42
KD-841SB	Panel, 44cm L	67	KD-960MP	Rectangular Crossbar, 80cmL - Polish	42
KD-842LB	Extension Panel with Holes, 108cm L	67	KD-960MP-N	Rectangular Crossbar, 64cmL - Polish	42
KD-842MB	Extension Panel with Holes, 82.5cm L	67	KD-960QP	Rectangular Crossbar, 62cmL - Polish	42
KD-842SB	Extension Panel with Holes, 44cm L	67	KD-960SB	Rectangular Crossbar, 41cmL - Black	42
KD-843LB	Extension Panel, 108cm L	67	KD-960SP	Rectangular Crossbar, 41cmL - Polish	42
KD-843MB	Extension Panel, 82.5cm L	67	KD-961B	Rectangular Crossbar Faceout, 41cm L - Black	42
KD-843SB	Extension Panel, 44cm L	67	KD-961P	Rectangular Crossbar Faceout, 41cm L - Polish	42
KD-850S	Sign frame Sidemount	36	KD-961P-25	Rectangular Crossbar Faceout, 25cm L - Polish	42
KD-851B	Mirror Frame - Black	36	KD-961SB	Rectangular Crossbar Faceout, 30cm L - Black	42
KD-851S	Mirror Frame - Silver	36	KD-962P	Layer Faceout For Rectangular Crossbar	42
KD-854S	Round Frame with Base, DIA. 50cm	37	KD-965P	Spiral Hanger	43
KD-855S	Round Frame, DIA. 50cm	37	KD-970P	Display Box	39
KD-856S	Round Frame, DIA. 60cm	37	KD-970P-A	Holding Arm, 29cm L	38
KD-900B	Donut (3 way clamp) - Black	22	KD-971P	Shelf with Bent Edges	39
KD-900P	Donut (3 way clamp) - Polish	22	KD-980LB	Span, DIA. 3.5cm, 106cm L - Black	43
KD-9101B	Salon Tool Holder	49	KD-980LP	Span, DIA. 3.5cm, 106cm L - Polish	43
KD-9102B	Salon Tool Holder with Power Outlet	49	KD-980MB	Span, DIA. 3.5cm, 80cm L - Black	43
KD-9103B	Salon Appliance Holder	49	KD-980MP	Span, DIA. 3.5cm, 80cm L - Polish	43
KD-9104B	Salon Appliance Holder with Power Outlet	49	KD-980QB	Span, DIA. 3.5cm, 62cm L - Black	43
KD-910B	Panel Holder - Black	28	KD-980QP	Span, DIA. 3.5cm, 62cm L - Polish	43
KD-910P	Panel Holder - Polish	28	KD-980SB	Span, DIA. 3.5cm, 41cm L - Black	43
KD-910P-G	Panel Holder with Double Set Screw - Polish	28	KD-980SP	Span, DIA. 3.5cm, 41cm L - Polish	43
KD-9121P	Bottle Rack	40	KD-980WSP	Span Wall Mount	61
KD-915B	Tidy Panel Holder (1.5cm) - Black	30	KD-981B	Span with Hanger Stop - Black	43
KD-915P	Tidy Panel Holder (1.5cm) - Silver	30	KD-981P	Span with Hanger Stop - Polish	43

INDEX

Code	Description	Page	Code	Description	Page
KD-982P	Wall Mount	61	KD-C1414B	Super Joint Double Y Island	64
KD-983TP	Banner Rod with Screw, 61cm L	35	KD-C1500B	Span Tube, DIA. 3.5cm, 150cm L - Black	67
KD-985P	U Hanging Rod	44	KD-C1500P	Span Tube, DIA. 3.5cm, 150cm L - Polish	67
KD-990B	L Bracket Shelf Holder, Set of 2 - Black	30	KD-C2000B	Span Tube, DIA. 3.5cm, 200cm L - Black	67
KD-990P	L Bracket Shelf Holder, Set of 2 - Silver	30	KD-C2000P	Span Tube, DIA. 3.5cm, 200cm L - Polish	67
KD-991B	L Bracket Shelf Holder with Knob, Set of 2 - Black	30	KD-C25P	Owlet clip (Set of 4)	58
KD-991P	L Bracket Shelf Holder with Knob, Set of 2 - Polish	30	KD-C40P	Owl clip (Set of 4)	58
KD-A001	Steel Hook (For Tube DIA. 40mm)	56	KD-C50P	Kupole Suspended Ceiling Adapter	60
KD-A002	Steel Hook (For Tube DIA. 45mm)	56	KD-CF16P	Ceiling Clip with Female Socket	60
KD-A003	Steel Faceout (For Tube DIA. 40mm)	56	KD-CM16P	Ceiling Clip with Male Adapter	60
KD-A004	Steel Faceout (For Tube DIA. 45mm)	56	KD-CS0500B	Steel Tube, DIA. 3.5cm, 50cm L - Black	67
KD-A005	Guitar Holder (For Tube DIA. 40mm)	57	KD-CS0500P	Steel Tube, DIA. 3.5cm, 50cm L - Polish	67
KD-A006	Guitar Holder (For Tube DIA. 45mm)	57	KD-CS1000B	Steel Tube, DIA. 3.5cm, 100cm L - Black	67
KD-B003P	Bubble Level	58	KD-CS1000P	Steel Tube, DIA. 3.5cm, 100cm L - Polish	67
KD-B005P	Security Collar	58	KD-CS1500B	Steel Tube, DIA. 3.5cm, 150cm L - Black	67
KD-B126P	Kupole Tripod Base	61	KD-CS1500P	Steel Tube, DIA. 3.5cm, 150cm L - Polish	67
KD-C01B	Curved Clamp - Black	65	KD-CS2000B	Steel Tube, DIA. 3.5cm, 200cm L - Black	67
KD-C01P	Curved Clamp - Polish	65	KD-CS2000P	Steel Tube, DIA. 3.5cm, 200cm L - Polish	67
KD-C02B	2 Ways Joint - Black	65	KD-F50P	Kupole Finial (For Tube DIA. 4cm)	59
KD-C02P	2 Ways Joint - Polish	65	KD-F51P	Kupole Finial (For Tube DIA. 4.5cm)	59
KD-C03B	Joint with Screw - Black	65	KD-F95P	Kupole Female Socket	59
KD-C03P	Joint with Screw - Polish	65	KD-K01BL	Kube (KD-K40, KD-K4037 and KD-K45) - Blue	50
KD-C04B	Variable Angle Joint - Black	65	KD-K01C	Kube (KD-K40, KD-K4037 and KD-K45) - Clear	50
KD-C04P	Variable Angle Joint - Polish	65	KD-K06P	Acrylic Holder	51
KD-C0500B	Span Tube, DIA. 3.5cm, 50cm L - Black	67	KD-K15P	Connecting Bars, Set of 2	51
KD-C0500P	Span Tube, DIA. 3.5cm, 50cm L - Polish	67	KD-K16P	Kube Base Bars, Set of 2	51
KD-C05B	Mini Donut - Black	65	KD-K4037BL	Acrylic shelf-Clear 40CMx37CM - Blue	50
KD-C05P	Mini Donut - Polish	65	KD-K4037C	Acrylic shelf-Blue 40CMx37CM - Clear	50
KD-C06B	Y Connector - Black	65	KD-K40BL	Acrylic Curved Shelf, 40cm L, Set of 2 - Blue	50
KD-C06P	Y Connector - Polish	65	KD-K40C	Acrylic Curved Shelf, 40cm L, Set of 2 - Clear	50
KD-C07B-C	Caster Adapter for Tube Insert - Black	66	KD-K45P	Bar with 8 Channels, Set of 2	51
KD-C07P	Foot Adapter - Polish	66	KD-K6037BL	Acrylic shelf-Clear 40CMx57CM - Blue	50
KD-C07P-C	Caster Adapter for Tube Insert - Polish	66	KD-K6037C	Acrylic shelf-Blue 40CMx57CM - Clear	50
KD-C08B	Caster Adapter - Black	66	KD-K60BL	Acrylic Curved Shelf, 60cm L, Set of 2 - Blue	50
KD-C08P	Caster Adapter - Polish	66	KD-K60C	Acrylic Curved Shelf, 60cm L, Set of 2 - Clear	50
KD-C09B	Base Flange - Black	66	KD-M01P	LCD Monitor Arm	47
KD-C09P	Base Flange - Polish	66	KD-M02P	Universal TV Tilt Mount	47
KD-C1000B	Span Tube, DIA. 3.5cm, 100cm L - Black	67	KD-PR30LP	Square Crossbar Adjustable from 105cm to 108cm	44
KD-C1000P	Span Tube, DIA. 3.5cm, 100cm L - Polish	67	KD-PR30MP	Square Crossbar Adjustable from 80cm to 83cm	44
KD-C1412B	Super Joint Y Island	64	KD-PR30QP	Square Crossbar Adjustable from 56cm to 59cm	44

INDEX

Code	Description	Page	Code	Description	Page
KD-PR31P	Square Faceout, 30.5cm L	44	KPC-A1211E	Corner For Tube O.d. 48.30mm (1.90")	69
KD-PR50P	Wall mount, Set of 2	61	KPC-A1212	90 Degree Crossover For Tube O.d. 48.30mm (1.90")	69
KD-PR910P	Rotating Adapter	28	KPC-A1217ADJ	Swivel Elbow / Tee For Tube O.d. 48.30mm (1.90")	70
KD-R46P	Kupole Ceiling Mount	59	KPC-A1217E	Adjustable Elbow Or Tee For Tube O.d. 48.30mm (1.90")	69
KD-R47P	Kupole Floor Mount	59	KPC-A1217M	Male Tab Of Swivel For Tube O.d. 48.30mm (1.90")	69
KD-R48-B	Disc Base Adapter	59	KPC-A1219E	Double Swivel Combination For Tube O.d. 48.30mm (1.90")	70
KD-R48P	Kupole Disc Base	59	KPC-A1230C	Short Tee Swivel For Tube O.d. 48.30mm (1.90")	70
KD-T50P	Kupole Coupler	60	KPC-A1242	Round Base Flange For Tube O.d. 48.30mm (1.90")	70
KD-TM10	Screw	60	KPC-A1246	Railing Base Flange For Tube O.d. 42.40mm (1.66")	70
KP-1628P	Banner Pole with KD-R48P-4MM	20	KPC-A1246ADJ	Adjustable Flange For Tube O.d. 42.40mm (1.66")	71
KP-1628P-SETA	Banner Pole Set (with Base, Donut & Square Clip)	20	KPC-A1250	Side Palm Fixing For Tube O.d. 42.40mm (1.66")	71
KP-2700-45B	Kupole Lower Tube (270cm) - Black	21	KPC-A1262	Plug For Tube O.d. 42.40mm (1.66")	71
KP-2700-45P	Kupole Lower Tube (270cm) - Polish	21	KPC-A1270	Sleeve Joint For Tube O.d. 42.40mm (1.66")	71
KP-L2137-45B	Kupole Lower Tube (178cm) - Black	21	KPC-A1282A	Handrail Bracket For Tube O.d. 48.30mm (1.90")	71
KP-L2137-45P	Kupole Lower Tube (178cm) - Polish	21	KPC-A1403	90 Degree For Tube O.d. 42.40mm (1.66")	68
KP-L2137BC	Kupole, 2.1m to 3.7m, w/Curvy handle - Black	17	KPC-A1403AE	Adjustable Elbow For Tube O.d. 42.40mm (1.66")	68
KP-L2137BD	Kupole, 2.1m to 3.7m - Black	18	KPC-A1405	Long Tee For Tube O.d. 42.40mm (1.66")	68
KP-L2137PC	Kupole, 2.1m to 3.7m, w/Curvy handle - Polish	17	KPC-A1405E	Short Tee For Tube O.d. 42.40mm (1.66")	68
KP-L2137PD	Kupole, 2.1m to 3.7m - Polish	18	KPC-A1407E	Two Socket Cross For Tube O.d. 42.40mm (1.66")	69
KP-M1527BC	Kupole, 1.5m to 2.7m, w/Curvy handle - Black	17	KPC-A1409	3 Way 90 Degree For Tube O.d. 42.40mm (1.66")	69
KP-M1527BD	Kupole, 1.5m to 2.7m - Black	18	KPC-A1411E	Corner For Tube O.d. 42.40mm (1.66")	69
KP-M1527PC	Kupole, 1.5m to 2.7m, w/Curvy handle - Polish	17	KPC-A1412	90 Degree Crossover For Tube O.d. 42.40mm (1.66")	69
KP-M1527PD	Kupole, 1.5m to 2.7m - Polish	18	KPC-A1417ADJ	Swivel Elbow / Tee For Tube O.d. 42.40mm (1.66")	70
KP-S1017BD	Kupole, 1.0m to 1.7m - Black	18	KPC-A1417E	Adjustable Elbow Or Tee For Tube O.d. 42.40mm (1.66")	69
KP-S1017PD	Kupole, 1.0m to 1.7m - Polish	18	KPC-A1417M	Male Tab Of Swivel For Tube O.d. 42.40mm (1.66")	69
KP-SP01	Rubber Pad - White	18	KPC-A1419E	Double Swivel Combination For Tube O.d. 42.40mm (1.66")	70
KP-SP02	Top Rubber Cover - White	18	KPC-A1430C	Short Tee Swivel For Tube O.d. 42.40mm (1.66")	70
KP-SP03	Bottom Rubber Cover - White	18	KPC-A1442	Round Base Flange For Tube O.d. 42.40mm (1.66")	70
KP-SP04	Top Rubber Cover - Black	18	KPC-A1446	Adjustable Flange For Tube O.d. 48.30mm (1.90")	70
KP-SP05	Bottom Rubber Cover - Black	18	KPC-A1446ADJ	Side Palm Fixing For Tube O.d. 48.30mm (1.90")	71
KP-X15B	Kupole Extension, Height 150cm - Black	21	KPC-A1450	Plug For Tube O.d. 48.30mm (1.90")	71
KP-X15P	Kupole Extension, Height 150cm - Polish	21	KPC-A1462	Sleeve Joint For Tube O.d. 48.30mm (1.90")	71
KP-X20B	Kupole Extension, Height 200cm - Black	21	KPC-A1470	Handrail Bracket For Tube O.d. 48.30mm (1.90")	71
KP-X20P	Kupole Extension, Height 200cm - Polish	21	KPG-L2137P	Gyro-pole - Polish	19
KPC-A1203	90 Degree For Tube O.d. 48.30mm (1.90")	68	KPS-2700-45B	Steel Kupole Lower Tube (270cm) - Black	21
KPC-A1203AE	Adjustable Elbow For Tube O.d. 48.30mm (1.90")	68	KPS-2700-45P	Steel Kupole Lower Tube (270cm)- Polish	21
KPC-A1205	Long Tee For Tube O.d. 48.30mm (1.90")	68	KPS-L2137GC	Steel Kupole w/Curvy handle - Gray	19, 54
KPC-A1205E	Short Tee For Tube O.d. 48.30mm (1.90")	68	KS-012	U Hook	31
KPC-A1207E	Two Socket Cross For Tube O.d. 48.30mm (1.90")	69	KS-017	Adapter (for KCP-350 or KCP-360)	32
KPC-A1209	3 Way 90 Degree For Tube O.d. 48.30mm (1.90")	69	KS-020	Adapter (for KCP-350 or KCP-360)	33

INDEX

Code	Description	Page	Page
KS-020S	Adapter (for KCP-350 or KCP-360)	32	
KS-094	Sold Steel Righth Angle (For KD-300)	46	
KS-550	Ipad Holder Kits with Security Cable Lock Key	47	
KXB-6-100	100cm X-BONE	72	
KXB-6-20	20cm X-BONE	72	
KXB-6-40	40cm X-BONE	72	
KXB-6-60	60cm X-BONE	72	
KXB-6-80	80cm X-BONE	72	
KXB-AK	Accessory Kit	72	
KXB-FP	Plastic Foot Pad	72	

**HEADQUARTERS
KUPO CO., LTD**

6f, No.4, Lane 609, Sec. 5,
Chung Shin Rd., San Chung
District, New Taipei City,
24159, Taiwan
TEL: +886-2-2999-1906
FAX: +886-2-2999-1955
E-MAIL: display@kupo.com.tw

**BRANCH
KUPO SHANGHAI**

No.25 & 26, Lane 5398
Shenzhuan Road, Shanghai, China
TEL: +86-21-5677-9636



Product catalog download

YOUR BEST DISPLAY PARTNER

[NOTE] Whilst every effort has been made to ensure the accuracy of the information / material contained within this catalogue, Kupo does not accept any liability for errors or omissions. Specifications and technical data are provided for guidance purposes only. To improve products, we reserve the right to make any variation in design or construction to the equipment description without prior notice.

www.displayshop.com.tw

